

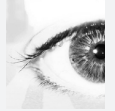

# Vision Sensor

## PHA250-F200A-R2-5833



- Detects the position of an index hole
- Large capture range
- High operating range
- Integrated contrast compensation
- Compact design
- Integrated illumination

Precision positioning on hole in the 70 mm x 70 mm housing



### Function

The sensor has been developed for the precision positioning of high-bay racking operating equipment. It detects circular holes in the racking structure and their positional deviation from the nominal position. The sensor operates in two dimensions.

### Dimensions

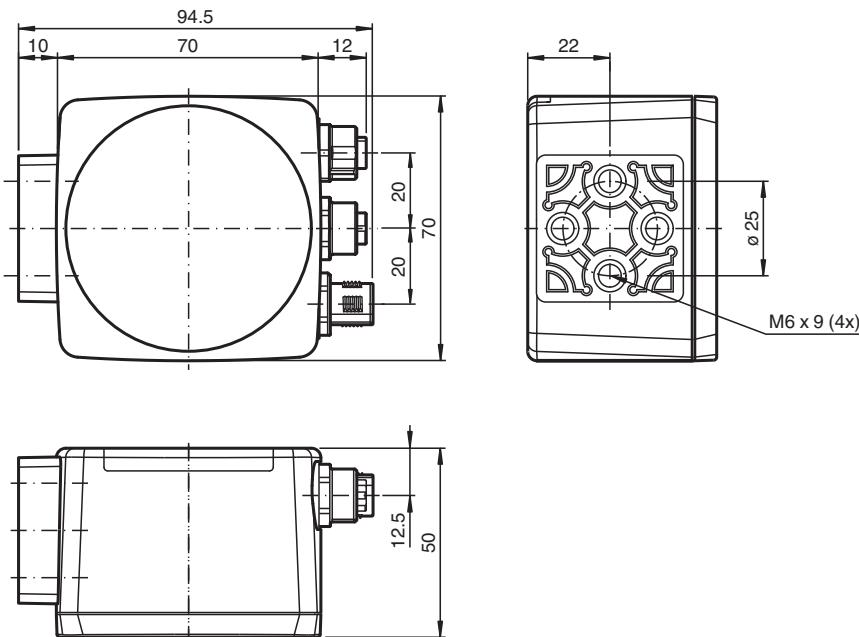

Release date: 2020-03-26 Date of issue: 2020-03-27 Filename: 254256\_eng.pdf

### Technical Data

#### General specifications

Light source	LED
Light type	Integrated LED lightning (infrared)
Object size	Hole diameter 13 mm
Response delay	100 ms

Refer to "General Notes Relating to Pepperl+Fuchs Product Information".

Pepperl+Fuchs Group  
www.pepperl-fuchs.com

USA: +1 330 486 0001  
fa-info@us.pepperl-fuchs.com

Germany: +49 621 776 1111  
fa-info@de.pepperl-fuchs.com

Singapore: +65 6779 9091  
fa-info@sg.pepperl-fuchs.com

**PF** PEPPERL+FUCHS

## Technical Data

Read distance	250 mm
Depth of focus	± 50 mm
Relative stroke	-10 mm
Capture range	max. 120 mm x 100 mm
<b>Nominal ratings</b>	
Camera	
Type	CMOS , Global shutter
Number of pixels	752 x 480 pixels
Gray scale	256
<b>Functional safety related parameters</b>	
MTTF <sub>d</sub>	70 a
Mission Time (T <sub>M</sub> )	10 a
Diagnostic Coverage (DC)	0 %
<b>Indicators/operating means</b>	
Operation indicator	LED green: Ready for operation
Function indicator	4 x LED yellow: +X, -X, +Y, -Y
Control elements	none
<b>Electrical specifications</b>	
Operating voltage	U <sub>B</sub> 24 V DC ± 15% , PELV
No-load supply current	I <sub>0</sub> max. 250 mA
Power consumption	P <sub>0</sub> 6 W
<b>Interface</b>	
Interface type	serial , RS 232
Transfer rate	max. 115.2 kBit/s
Cable length	max. 30 m
<b>Interface 1</b>	
Interface type	Ethernet
Protocol	TCP/IP
Transfer rate	100 MBit/s
Cable length	max. 30 m
<b>Input</b>	
Input voltage	to be applied externally 24 V ± 15% PELV
Number/Type	Cycle stop, relative stroke
Input current	1.6 mA at 24 V
Switching threshold	low: < 10 V, high: > 15 V
Cable length	max. 30 m
<b>Output</b>	
Switching type	PNP , short-circuit/overload protected
Signal output	+X, -X, +Y, -Y
Switching voltage	24 V
Switching current	max. 100 mA each output
Cable length	max. 30 m
<b>Compliance with standards and directives</b>	
Directive conformity	
EMC Directive 2004/108/EC	EN 61326-1 , EN 61000-6-4
Standard conformity	
Noise immunity	EN 61326-1:2006
Emitted interference	EN 61000-6-4:2007/A1:2011
<b>Approvals and certificates</b>	
UL approval	cULus Listed, General Purpose, Class 2 Power Source, Type 1 enclosure
CCC approval	CCC approval / marking not required for products rated ≤36 V
Approvals	CE
<b>Ambient conditions</b>	

Release date: 2020-03-26 Date of issue: 2020-03-27 Filename: 254256\_eng.pdf

Refer to "General Notes Relating to Pepperl+Fuchs Product Information".

Pepperl+Fuchs Group  
www.pepperl-fuchs.com

USA: +1 330 486 0001  
fa-info@us.pepperl-fuchs.com

Germany: +49 621 776 1111  
fa-info@de.pepperl-fuchs.com

Singapore: +65 6779 9091  
fa-info@sg.pepperl-fuchs.com

 **PEPPERL+FUCHS**

**Technical Data**

Operating temperature	0 ... 60 °C (32 ... 140 °F) , -20 ... 60 °C (-4 ... 140 °F) (noncondensing; prevent icing on the lens!)
Storage temperature	-20 ... 85 °C (-4 ... 185 °F)
Relative humidity	90 % , noncondensing
Shock resistance	< 50 g
Vibration resistance	< 3 G , 11 ... 200 Hz
<b>Mechanical specifications</b>	
Degree of protection	IP67
Connection	8-pin, M12x1 connector, standard (supply+IO) , 5-pin, M12x1 socket, standard (RS 232) , 4-pin, M12x1 socket, standard (LAN)
Material	
Housing	PC/ABS
Optical face	Plastic pane
Installation	4 x M6 threading
Mass	approx. 160 g

**Connection**

**RS 232**



Pin	Signal
1	+UB
2	TX RS232
3	GND
4	RX RS232
5	NC

**LAN**

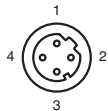

Pin	Signal
1	TX+ Ethernet
2	RX+ Ethernet
3	TX- Ethernet
4	RX- Ethernet

**24 V DC+IO**

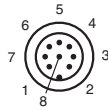

Pin	Signal
1	OUT +X
2	+UB
3	OUT -Y
4	OUT +Y
5	OUT -X
6	IN 1
7	GND
8	IN 2

Release date: 2020-03-26 Date of issue: 2020-03-27 Filename: 254256\_eng.pdf

Refer to "General Notes Relating to Pepperl+Fuchs Product Information".



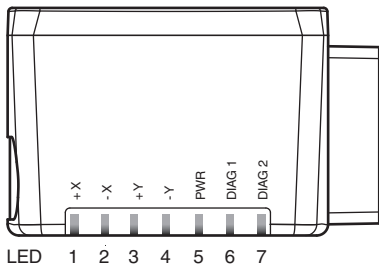
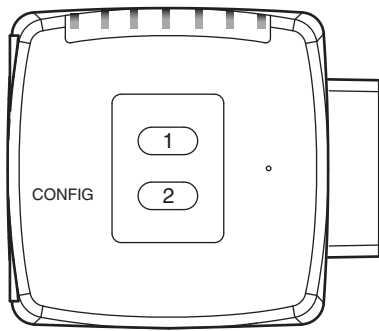

## Assembly

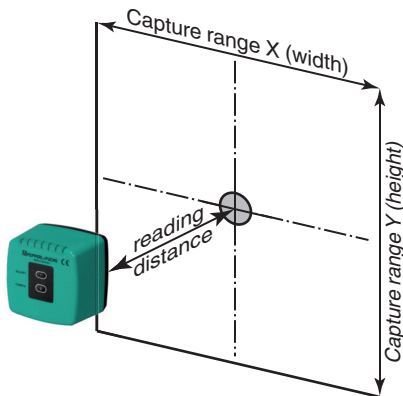

## Characteristic Curve



## Accessories

	<b>V19-G-5M-PUR-ABG</b>	Female cordset, M12, 8-pin, shielded, PUR cable
	<b>V15S-G-5M-PUR-ABG</b>	Male cordset, M12, 5-pin, shielded, PUR cable
	<b>V1SD-G-2M-PUR-ABG-V45-G</b>	Connection cable, M12 to RJ-45, PUR cable 4-pin, CAT5e
	<b>V1SD-G-2M-PUR-ABG-V45X-G</b>	Connection cable, M12 to RJ-45, PUR cable 4-pin, CAT5e
	<b>PCV-MB1</b>	Mounting bracket for PCV* read head

Release date: 2020-03-26 Date of issue: 2020-03-27 Filename: 254256\_eng.pdf

Refer to "General Notes Relating to Pepperl+Fuchs Product Information".

Pepperl+Fuchs Group  
www.pepperl-fuchs.com

USA: +1 330 486 0001  
fa-info@us.pepperl-fuchs.com

Germany: +49 621 776 1111  
fa-info@de.pepperl-fuchs.com

Singapore: +65 6779 9091  
fa-info@sg.pepperl-fuchs.com

## Accessories

Other suitable accessories can be found at [www.pepperl-fuchs.com](http://www.pepperl-fuchs.com)

Release date: 2020-03-26 Date of issue: 2020-03-27 Filename: 254256\_eng.pdf

Refer to "General Notes Relating to Pepperl+Fuchs Product Information".

Pepperl+Fuchs Group  
[www.pepperl-fuchs.com](http://www.pepperl-fuchs.com)

USA: +1 330 486 0001  
[fa-info@us.pepperl-fuchs.com](mailto:fa-info@us.pepperl-fuchs.com)

Germany: +49 621 776 1111  
[fa-info@de.pepperl-fuchs.com](mailto:fa-info@de.pepperl-fuchs.com)

Singapore: +65 6779 9091  
[fa-info@sg.pepperl-fuchs.com](mailto:fa-info@sg.pepperl-fuchs.com)

 **PEPPERL+FUCHS**