

EEH210

Digital humidity and temperature sensor

Well proven humidity sensor element, state-of-the-art ASIC technology and highly accurate humidity and temperature adjustment represent the basis for outstanding performance of the digital humidity and temperature sensor EEH210. The proprietary E+E coating protects the sensor against dirt and corrosion, which leads to excellent long-term stability even in polluted environment. The measured values are available on the digital interfaces I²C, SPI, PWM and PDM.

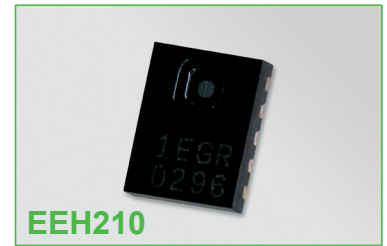

1. FEATURES

- Multipoint humidity / temperature factory calibration
- Excellent long term stability due to the E+E proprietary coating
- Long standing proven sensor technology
- DFN enclosure 3.6 x 2.8 x 0.75 mm
- 4 digital interfaces: I²C, SPI, PWM and PDM
- Supply voltage 3 V

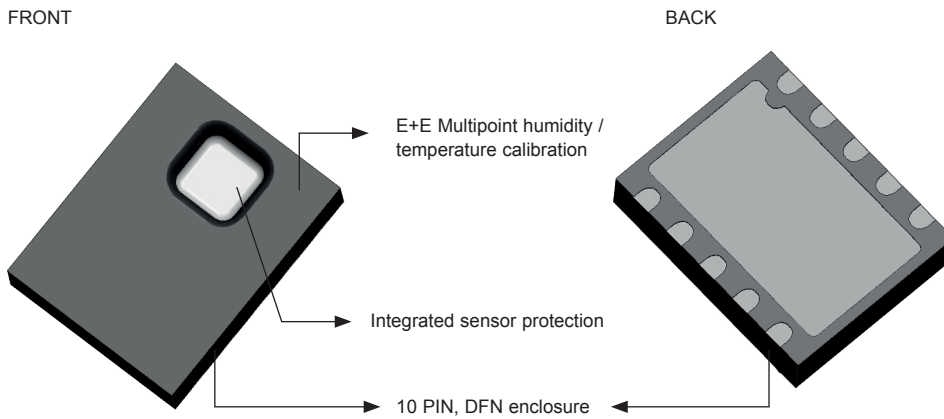

Figure 1: Description

2. DIMENSIONS (MM/INCH)

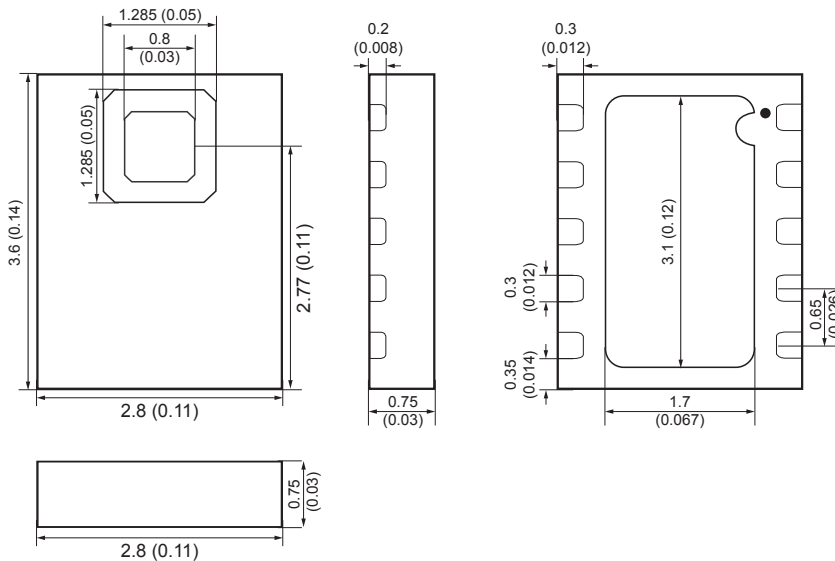

Figure 2: Dimensions

3. SENSOR PERFORMANCE

EEH210 is a relative humidity sensor and temperature sensor with band gap circuit, it contains oscillator, A/D convertor, regulator, D/A convertor, NVM, digital processing unit and calibration circuit.

3.1. RELATIVE HUMIDITY SENSOR

PARAMETER	CONDITION	MIN	TYP	MAX	UNITS
Resolution ¹⁾	12 bit		0.04		% RH
	8 bit		0.7		% RH
Accuracy Tolerance ²⁾	typ		±2.0		% RH
Repeatability	12 bit		±0.1		% RH
Hysteresis			±1		% RH
Response Time ³⁾				10	sec
Operating Range	extended ⁴⁾	0		100	% RH
Long Term Drift ⁵⁾			0.5		% RH/yr

Table 1: Relative Humidity Sensor

1. Default resolution is 14 bit (temperature) / 12 bit (humidity). It can be reduced to 12/8 bit, 11/11 bit or 13/10 bit by command.
2. Accuracies are tested at Outgoing Quality Control at 25 °C and 5.0 V. Values exclude hysteresis and long term drift and are applicable to non-condensing environments only.
3. Time for achieving 63 % of a step function, valid at 25 °C and 1m/s airflow.
4. Standard operating range: 0-80 % RH, beyond this limit sensor may read a reversible offset with slow kinetics (+3 % RH after 60h at humidity >80 % RH).
5. Value may be higher in environments with vaporized solvents, out-gassing tapes, adhesives, packaging materials, etc. For more details please refer to Handling Instructions.

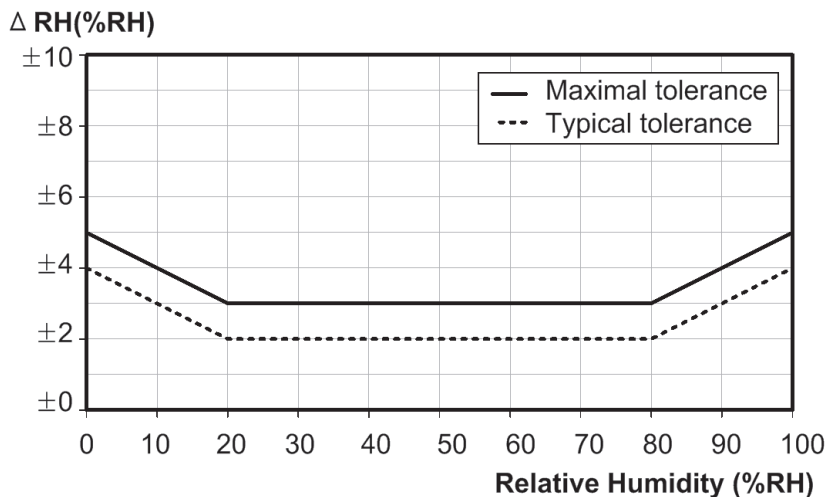

Figure 3: Typical and maximal tolerance at 25 °C for relative humidity.

3.2. TEMPERATURE SENSOR

PARAMETER	CONDITION	MIN	TYP	MAX	UNITS
Resolution ¹⁾	14 bit		0.01		°C
	12 bit		0.04		°C
Accuracy Tolerance	14 bit		±0.3		°C
Repeatability	12 bit		±0.1		°C
Response Time ²⁾				30(TBD)	sec
Operating Range	extended ³⁾	-40		125	°C
Long Term Drift			0.05		°C/yr

Table 2: Temperature Sensor

1. Default resolution is 14 bit (temperature) / 12 bit (humidity). It can be reduced to 12/8 bit, 11/11 bit or 13/10 bit by command.
2. Response time depends on heat conductivity of sensor substrate.
3. Standard operating range: -30 ~ +85 °C, exposure to beyond this normal operating range for extended periods may affect the device reliability.

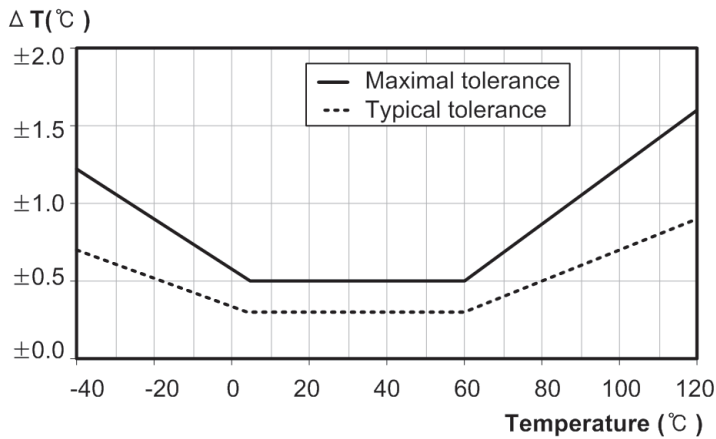

Figure 4: Typical and maximal tolerance for temperature

3.3. OPERATING RANGE

The standard working range with regard to the humidity / temperature limits is shown by the dark gray area in Figure 5. The relative humidity signal may offset temporarily as a result of continuous exposure to conditions outside the dark gray region, especially at humidity > 80 % RH. If the sensor is brought back to the standard working range, the initial values will recover. Applications with high humidity at high temperatures will result in slower recovery. Reconditioning procedures (see 8.5) can accelerate this process. Although the sensors would not fail beyond standard working range limits, the specification is guaranteed within the standard working range only.

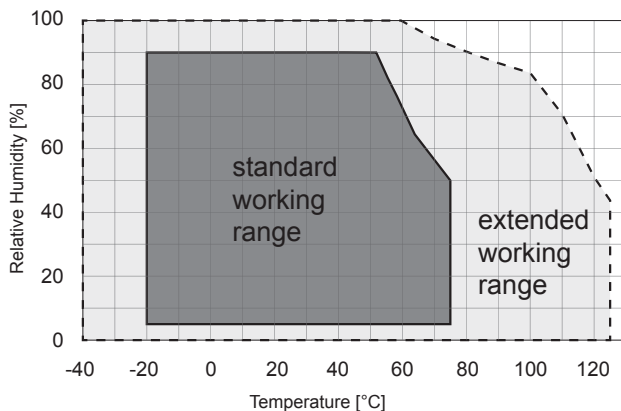

Figure 5: Working range

4. ELECTRICAL CHARACTERISTICS

4.1. ABSOLUTE MAXIMUM RATINGS

The absolute maximum ratings as given in Table 3 are stress ratings only and give additional information. Functional operation of the device at these conditions is not implied. Exposure to absolute maximum rating conditions for extended periods may affect the device reliability (e.g. hot carrier degradation, oxide breakdown).

SYMBOL	PARAMETER	MIN	MAX	UNIT
VDD	Power Supply	-0.3	4.3	V
VLOGIC	Digital I/O Pins (SDA, SCL, SEL[1:0])	-0.3	VDD + 0.3	V
I _{IN}	Input Current on any Pin	-100	100	mA
T _{STG}	Storage Temperature	-55	150	°C
T _{OP}	Operation Temperature	-40	125	°C

Table 3: Absolute maximum ratings

4.2. ELECTRICAL SPECIFICATION

The electrical characteristics such as power consumption, low and high level input and output voltages depend on the supply voltage. For proper communication with the sensor it is essential to make sure that signal design is strictly within the limits given in Table 4, Table 5 and Figure 6.

PARAMETER	CONDITION	MIN	TYP	MAX	UNITS
Supply Voltage	VDD	2.1	3.0	3.6	V
Current Dissipation	Sleep		0.5		μA
	Measuring, SEL[1:0]=00		450(TBD)		μA
	Average 8bit ⁽¹⁾ , SEL[1:0]=00		3(TBD)		μA
PWM Freq.	SEL[1:0]=01, 30 °C	108	120	132	Hz
Measure Freq.	SEL[1:0]=01,10		2		Hz
Communication	SPI and I ² C interfaces				

Table 4: DC characteristics of digital input/output pads. VCC = 3 V, T = 25 °C, unless otherwise noted.

PARAMETER	SYMBOL	MIN	TYP	MAX	UNITS
Output Low Voltage	V _{OL}	0	-	0.4	V
Output High Voltage	V _{OH}	VDD X 0.7	-	VDD	V
Output Sink Current	I _{OL}	-	-	-4	mA
Input Low Voltage	V _{IL}	0	-	VDD X 0.3	V
Input High Voltage	V _{IH}	VDD X 0.7	-	VDD	V
SCL Frequency	f _{SCL}	0	-	0.4	MHz
SCL High Time	t _{SCLH}	0.6	-	-	μs
SCL Low Time	t _{SCLL}	1.3	-	-	μs
SDA Set-Up Time	t _{SU}	100	-	-	ns
SDA Hold Time	t _{HD}	0	-	900	ns
SDA Valid Time	t _{VD}	0	-	400	ns
SCL/SDA Fall Time	t _F	20	-	300	ns
SCL/SDA Rise Time	t _R	20	-	300	ns
Start condition setup time	t _{SUSTA}	100	-	-	ns
Start condition hold time	t _{HDSTA}	100	-	-	ns
Stop condition setup time	t _{SUSTO}	100	-	-	ns
Bus free time between stop condition and start condition	t _{BUS}	1.3	-	-	μs
Capacitive Load on Bus Line	C _b	0	-	400	pF

Table 5: Timing specifications of digital input/output pads for I²C fast mode. Entities are displayed in Figure 4. VDD = 3V, T = 25 °C, unless otherwise noted.

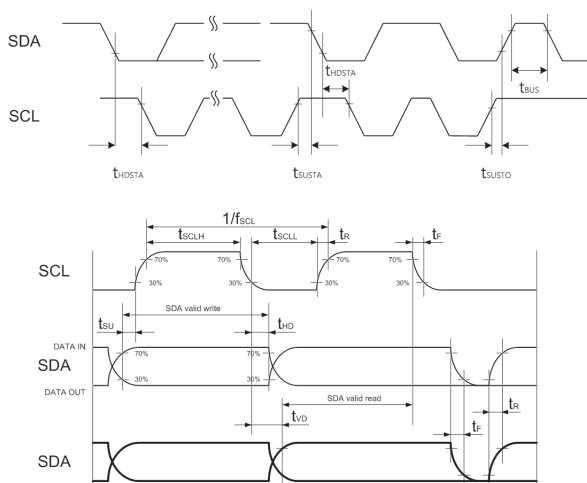

Figure 6: Timing Diagram for Digital Input / Output Pads, abbreviations are explained in Table 5. SDA directions are seen from the sensor. Bold SDA line is controlled by the sensor, plain SDA line is controlled by the micro-controller. Note that SDA valid read time is triggered by falling edge of anterior toggle.

PARAMETER	SYMBOL	MIN	TYP	MAX	UNITS
SPI clock cycle	$t_c(\text{SPC})$	100			ns
SPI clock frequency	$f_c(\text{SPC})$			10	MHz
CS setup time	$t_{su}(\text{CSB})$	6			ns
CS hold time	$t_h(\text{CSB})$	8			
SDIO input setup time	$t_{su}(\text{SI})$	5			
SDIO input hold time	$t_h(\text{SI})$	15			
SDIO valid output time	$t_v(\text{SO})$			50	
SDIO output hold time	$t_h(\text{SO})$	9			
SDIO output disable time	$t_{dis}(\text{SO})$			50	

Table 6: SPI - serial peripheral interface

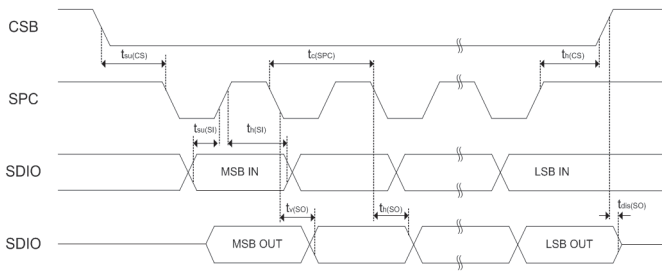

Figure 7: SPI slave timing diagram

Measurement point are done at $0.3 \cdot V_{DD}$ and $0.7 \cdot V_{DD}$, for both ports.

5. INTERFACE

5.1. PIN CONFIGURATION

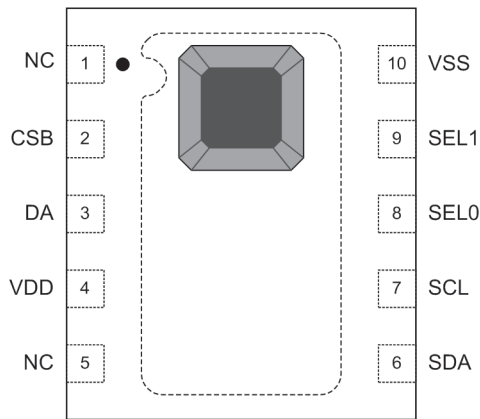

Figure 8: Pin Assignment (Through View): DFN-10 3.6 x 2.8

5.2. PIN DESCRIPTION

NAME	PIN#	TYPE	DESCRIPTION
NC	1	NC	No connect
CSB	2	I / NC	SPI mode: chip select input I ² C, PWM, PDM mode: floating (NC)
DA	3	O / NC	SPI mode: Data available output signal I ² C, PWM, PDM mode: floating (NC)
VDD	4	P	VDD Power Supply
NC	5	NC	No connection
SDA / SDIO	6	I/O	I ² C / SPI serial data signal & PWM / PDM Output
SCL / SPC	7	I/O	I ² C / SPI serial clock signal
SEL0	8	I	Mode Selection
SEL1	9	I	Mode Selection
VSS	10	G	Ground
EP			Exposed Pad. EP is electrically connected to GND.

Table 7: Pin description table

5.3. POWER PINS (VDD, VSS)

The recommended supply voltage of EEH210 is 3.0 V. Supply Voltage (VDD) and Ground (VSS) must be decoupled with a 100 nF capacitor, placed as close as possible to the sensor..

5.4. I²C/SPI MODE SELECTION, CSB

To select the I²C interface, the SEL[1:0]=00 & CSB= floating (internal pull-down), to select the SPI interface, SEL[1:0]=11 & CSB=input

5.5. SERIAL CLOCK, SCL/SPC

SCL is used to synchronize the communication between micro-controller (MCU) and the sensor. Since the interface consists of fully static logic there is no minimum SCL frequency. SPC is the serial port clock and it is controlled by the SPI master.

5.6. SERIAL DATA & BIT STREAM, SDA/SDIO

The SDA/SDIO port is used as two purposes according to the SEL[1:0] pin setting. The first is as I²C/SPI interface data port and the second is usage as PWM/PDM output port.

On SDA/SDIO the sensor is providing PWM/PDM output. The signal is carrying humidity or temperature data depending on SEL[1:0] setting. Refer to the Table 7.

When EEH210 is used at I²C interface mode, the SDA pin is used to transfer data in and out of the sensor. For sending a command to the sensor, SDA is valid on the rising edge of SCL and must remain stable while SCL is high. After the falling edge of SCL the SDA value may be changed. For safe communication SDA shall be valid t_{SU} and t_{HD} before the rising and after the falling edge of SCL, respectively – see Figure 4. For reading data from the sensor, SDA is valid t_{VD} after SCL has gone low and remains valid until the next falling edge of SCL.

To avoid signal contention the micro-controller unit (MCU) must only drive SDA and SCL low. External pull-up resistors (e.g. 10kΩ), are required to pull the signal high. For the choice of resistor size please take bus capacity requirements into account (compare Table 5). It should be noted that pull-up resistors may be included in I/O circuits of MCUs. See Table 4 and Table 5 for detailed I/O characteristic of the sensor.

When EEH210 is used at SPI interface mode, the SDIO pin is the serial port data input and output.

This pin is driven at the falling edge of SPC and should be captured at the rising edge of SPC. – see Figure 6.

SEL[1:0]	SCL/SPC	SDA/SDIO	DA	CSB
00		I ² C	Hi-z	Hi-z
01	0	PWM : T	Hi-z	Hi-z
	1	PWM : RH		
10	0	PDM : T		
	1	PDM : RH		
11		SPI	OUT	0

Table 8: SEL[1:0] pin setting condition table

The SCL pin has to be fixed as 'L' or 'H' under PWM/PDM mode.

5.7. STARTUP SENSOR

As a first step, the sensor is powered up to the chosen supply voltage VDD (typical 3.0 V). After power-up, the sensor needs at most 10 ms, while SCL is high, for reaching idle state, i.e. to be ready accepting commands from the master (MCU) or the sensor starts measuring and providing data on PWM/PDM bit-stream.

Whenever the sensor is powered up, but not performing a measurement or communicating, it is automatically in idle state (sleep mode).

5.8. POWER ON/OFF SEQUENCE

The recommended initial supply voltage (VDD) of EEH210 before power on state is Ground (VSS) level.

PARAMETER	SYMBOL	CONDITION	MIN	TYP	MAX	UNITS
Reset threshold voltage	VL	VDD=3V	-	-	0.2(TBD)	V
Under threshold duration	TL		0.5(TBD)	-	-	sec
VCC rising slew rate	VSL		0.25(TBD)	-	-	V/ms

Table 9: Power On/Off Timing specifications. Entities are displayed in Figure 9

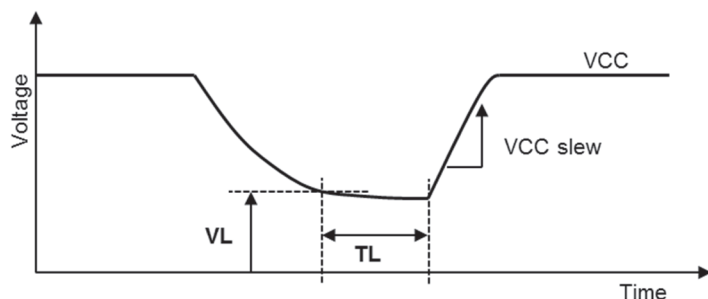

Figure 9: Power On/Off Sequence for proper operation.

6. COMMUNICATION BY I²C PROTOCOL WITH SENSOR

6.1. START / STOP SEQUENCE ON I²C

I²C communication can be initiated by sending a START condition from the master, a high-to-low transition on the SDA line while the SCL is high. A Stop condition, a low-to-high transition on the SDA line while the SCL input is high, is sent by the master (see Figure 10).

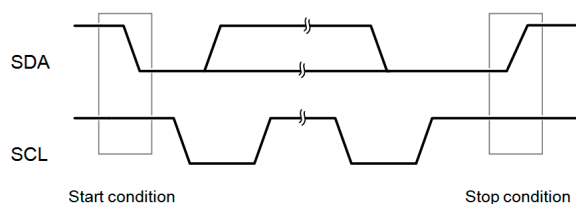

Figure 10: Definition of I²C Start and Stop Conditions

6.2. SENDING A COMMAND

After sending the Start condition, the subsequent I²C header consists of the 7 bit I²C device address '1000000' and an SDA direction bit (Read R: '1', Write W: '0'). The sensor indicates the proper reception of a byte by pulling the SDA pin low (ACK bit) after the falling edge of the 8th SCL clock.

After the issue of a measurement command ('11100011' for temperature, '11100101' for relative humidity), the MCU must wait for the measurement to complete. The basic commands are summarized in Table 8.

COMMAND	COMMENT	CODE
Trigger T+RH measurement	hold master	11100001
Trigger T measurement	hold master	11100011
Trigger RH measurement	hold master	11100101
Trigger T+RH measurement	no hold master	11110001
Trigger T measurement	no hold master	11110011
Trigger RH measurement	no hold master	11110101
Write user register		11100110
Read user register		11100111
Soft reset		11111110

Table 10: Basic command set, RH stands for relative humidity, and T stands for temperature.

6.3. HOLD / NO HOLD MASTER MODE

There are two different operation modes to communicate with the sensor: Hold Master mode or No Hold Master mode. In the first case the SCL line is blocked (controlled by sensor) during measurement process while in the latter case the SCL line remains open for other communication while the sensor is processing the measurement.

No hold master mode allows for processing other I²C communication tasks on a bus while the sensor is measuring. A communication sequence of the two modes is displayed in Figure 9 and Figure 10, respectively.

In the hold master mode, the EEH210 pulls down the SCL line while measuring to force the master into a wait state. By releasing the SCL line the sensor indicates that internal processing is terminated and that transmission may be continued.

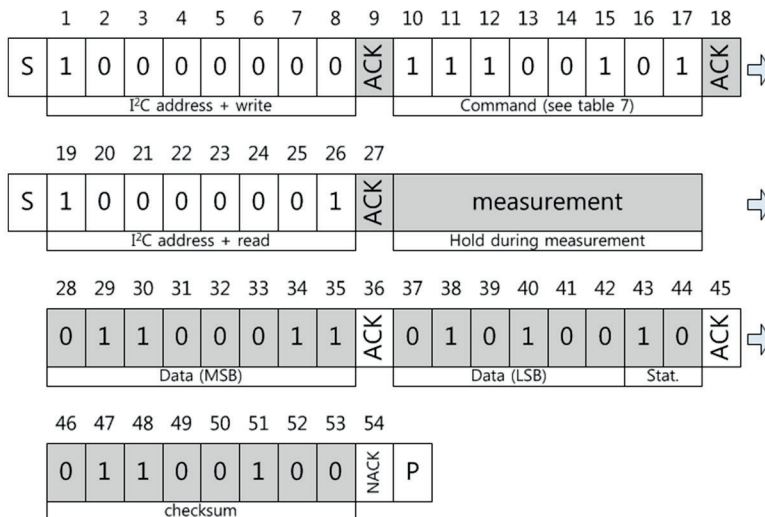

Figure 11: Hold master communication sequence – grey blocks are controlled by EEH210. Bit 45 may be changed to NACK followed by Stop condition (P) to omit checksum transmission.

In no hold master mode, the MCU has to poll for the termination of the internal processing of the sensor. This is done by sending a Start condition followed by the I²C header (10000001) as shown in Figure 10.

If the internal processing is finished, the sensor acknowledges the poll of the MCU and data can be read by the MCU. If the measurement processing is not finished the sensor answers no ACK bit and the Start condition must be issued once more.

For both modes, since the maximum resolution of a measurement is 14 bit, the two last least significant bits (LSBs, bits 43 and 44) are used for transmitting status information. Bit 1 of the two LSBs indicates the measurement type ('0':temperature, '1':humidity). Bit 0 is currently not assigned.

In the examples given in Figure 9 and Figure 10 the sensor output is DRH = '0110'0011'0101'0000'. For the calculation of physical values Status Bits must be set to '0' – see Chapter 5.

The maximum duration for measurements depends on the type of measurement and resolution chosen – values are displayed in Table 9. Maximum values shall be chosen for the communication planning of the MCU.

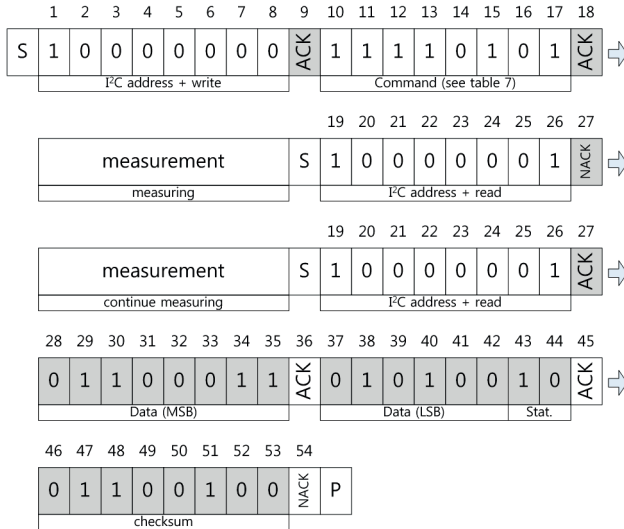

Figure 12: No Hold master communication sequence – grey blocks are controlled by EEH210. If measurement is not completed upon “read” command, sensor does not provide ACK on bit 27 (more of these iterations are possible). If bit 45 is changed to NACK followed by Stop condition (P) checksum transmission is omitted.

RESOLUTION	RH (TYP)	T (TYP)	UNITS
14 bit		16	ms
13 bit		8	ms
12 Bit	18	8	ms
11 bit	10	4	ms
10 bit	10		ms
8 bit	4		ms

Table 11: Measurement times for RH and T measurements at different resolutions

Please note: I²C communication allows for repeated Start conditions (S) without closing prior sequence with Stop condition (P) – compare Figures 9, 10 and 12. Still, any sequence with adjacent Start condition may alternatively be closed with a Stop condition.

6.4. SOFT RESET

This command (see Table 8) is used for rebooting the sensor system without switching the power off and on again. Upon reception of this command, the sensor system reinitializes and starts operation according to the default settings – with the exception of the heater bit in the user register (see Sect. 6.3). The soft reset takes less than 15 ms.



Figure 13: Soft Reset – grey blocks are controlled by EEH210.

6.5. USER REGISTER

The content of User Register is described in Table 10. Please note that reserved bits must not be changed and default values of respective reserved bits may change over time without prior notice. Therefore, for any writing to the User Register, default values of reserved bits must be read first. Thereafter, the full User Register string is composed of respective default values of reserved bits and the remainder of accessible bits optionally with default or non-default values.

OTP Reload is a safety feature and loads the entire OTP settings to the register before every measurement. This feature is disabled per default and is not recommended for use. Please use Soft Reset instead – it contains OTP Reload.

BIT	#BITS	DESCRIPTION / CODING	DEFAULT		
7,0	2	Measurement resolution		00	
			RH		Temp
		00	12 bit		14 bit
		01	8 bit		12 bit
		10	10 bit		13 bit
		11	11 bit	11 bit	
6	1	Status : End of battery ¹ 0: VDD > 2.25V 1: VDD < 2.25V		0	
5,4,3	3	Reserved		111	
2	1	Reserved		0	
1	1	Disable OTP reload		1	

Table 12: User Register. Reserved bits must not be changed. “OTP reload” = ‘0’ loads default settings after each time a measurement command is issued.

1. This status bit is updated after each measurement.

An example for I²C communication reading and writing the User Register is given in Figure 12.

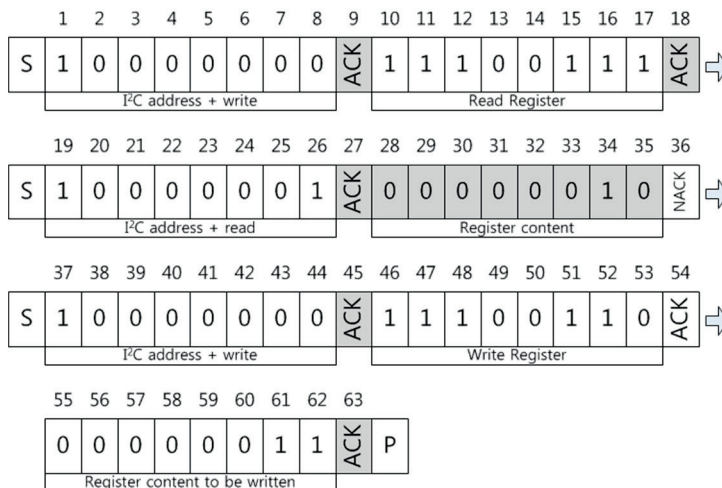

Figure 14: Read and write register sequence – grey blocks are controlled by EEH210. In this example, the resolution is set to 8 bit / 12 bit.

6.6. CRC CHECKSUM

The EEH210 provides a CRC-8 checksum for error detection.

The polynomial used is $x^8 + x^5 + x^4 + 1$.

6.7. CONVERSION OF SIGNAL OUTPUT

Default resolution is set to 12 bit relative humidity and 14 bit temperature reading.

Measured data are transferred in two byte packages, i.e. in frames of 8 bit length where the most significant bit (MSB) is transferred first (left aligned).

Each byte is followed by an acknowledge bit. The two status bits, the last bits of LSB, must be set to ‘0’ before calculating physical values.

In the example of Figure 9 and Figure 10, the transferred 16 bit relative humidity data is ‘0110001101010000’ = 25424.

Relative Humidity Conversion

With the relative humidity data output D_{RH} the relative humidity RH is obtained by the following formula (result in % RH), no matter which resolution is chosen:

$$RH = -6 + 125 \cdot \frac{D_{RH}}{2^{16}}$$

In the example given in Figure 9 and Figure 10 the relative humidity results to be 42.5 % RH.

$$RH = -6 + 125 \cdot \frac{25424}{65536} = 42.492 \approx 42.5$$

The physical value RH given above corresponds to the relative humidity above liquid water according to World Meteorological Organization (WMO). For relative humidity above ice RH_i the values need to be transformed from relative humidity above water RH_w at temperature t.

The equation is given in the following formular:

$$RH_i = RH_w \cdot \exp\left(\frac{\beta_w \cdot t}{\lambda_w + t}\right) / \exp\left(\frac{\beta_i \cdot t}{\lambda_i + t}\right)$$

Units are % RH for relative humidity and °C for temperature. The corresponding coefficients are defined as follows:

$\beta_w = 17.62$, $\lambda_w = 243.12$ °C, $\beta_i = 22.46$, $\lambda_i = 272.62$ °C.

Temperature Conversion

The temperature T is calculated by inserting temperature data output D_T into the following formula (result in °C), no matter which resolution is chosen:

$$T = -46.85 + 175.72 \cdot \frac{D_T}{2^{16}}$$

7. COMMUNICATION BY SPI BUS INTERFACE WITH SENSOR

The EEH210 SPI is a slave bus that can operate in SPI modes. The SPI allows to write and read the registers of the device. The serial interface consists of 3 wires: CSB, SPC, SDIO

CSB is the serial port enable and is controlled by the SPI master. It goes low at the start of the transmission and goes back high at the end. SPC is the serial port clock and it is controlled by the SPI master. It is stopped high when CSB is high (no transmission). SDIO is the serial port data input and output. This line is driven at the falling edge of SPC and should be captured at the rising edge of SPC

Both the read register and write register commands are completed in 16 clock pulses or in multiples of in case of multiple read/write bytes. Bit duration is the time between two falling edges of SPC. The first bit (bit0) start at the first falling edge of SPC after the falling edge of CSB while the last bit (bit15, bit23, ...) starts at the last falling edge of SPC just before the rising edge of CSB.

7.1. SPI WRITE

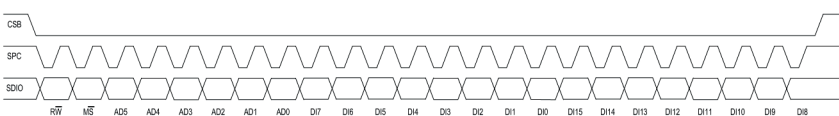
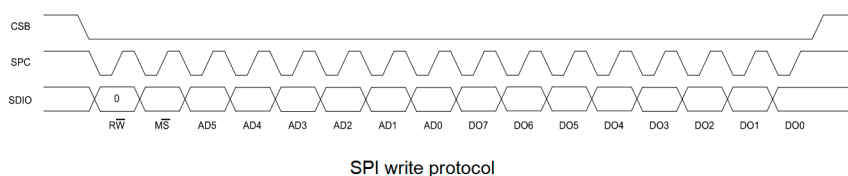

Figure 15: Multiple byte SPI write protocol (2-byte example)

7.2. SPI READ

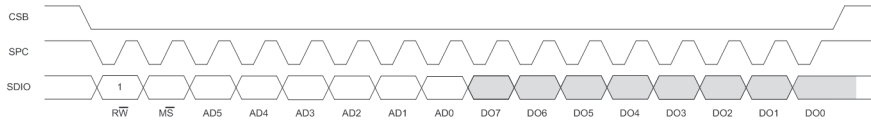

Figure 16: SPI read protocol in 3-wires mode

7.3. REGISTER MAPPING

NAME	TYPE	REGISTER ADDRESS (HEX)	DEFAULT (HEX)
DEVICE ID	R	0F	00
ADC_RESOL	R/W	10	00
CTRL_REG1	R/W	20	00
CTRL_REG2	R/W	21	00
CTRL_REG3	R/W	22	00
STATUS_REG	R	27	00
HUMIDITY_OUT_L	R	28	Output
HUMIDITY_OUT_H	R	29	Output
TEMP_OUT_L	R	2A	Output
TEMP_OUT_H	R	2B	Output

Table 13: Register mapping

7.4. REGISTER DESCRIPTION

DEVICE ID

7	6	5	4	3	2	1	0
1	0	1	1	1	1	0	0

Table 14: Device ID

Address: 0Fh (R)
 Description: This read-only register contains the device identifier, set to BCh

ADC_RESOL

7	6	5	4	3	2	1	0
Reserved	-	TRES1	TRES0	-	RHRES1	RHRES0	

Table 15: ADC_Resol

Address: 10h (R/W)
 Description: [7:5], [2] Reserved
 [4:3] TRES1-0: To select ADC resolution of Temperature measurement.
 [1:0] RHRES1-0: To select ADC resolution of Humidity measurement.

[TRES1:TRES0]	RESOLUTION	[RHRES1:RHRES0]	RESOLUTION
00	14bit	00	12bit
01	13bit	01	11bit
10	12bit	10	10bit
11	11bit	11	8bit

Table 16: ADC_Resol

CTRL_REG1

7	6	5	4	3	2	1	0
PD	Reserved				BDU	ODR1	ODR0

Table 17: CTRL_REG1

Address: 20h (R/W)
Description: [7] PD: power down control (0: power down mode, 1 : active mode)
[6:3] Reserved
[2] BDU: block data update
(0: continuous update, 1: output register not updated until MSB and LSB reading)
[1:0] ODR1, ODR0: output data rate selection

ODR1	ODR0	HUMIDITY (HZ)	TEMPERATURE (HZ)
0	0	One shot	
0	1	1 Hz	1 Hz
1	0	0.2 Hz	0.2 Hz
1	1	0.1 Hz	0.1 Hz

Table 18: CTRL_REG1

CTRL_REG2

7	6	5	4	3	2	1	0
BOOT	Reserved						ONE_SHOT

Table 19: CTRL_REG2

Address: 21h (R/W)
Description: Control register.
[7] BOOT: Reboot memory content (0: normal mode, 1: reboot memory content)
[6:1] Reserved
[0] One shot enable (0: waiting for start of conversion, 1: start for a new dataset)

The BOOT bit is used to refresh the content of the internal register stored in the eFUSE block. At device power-up, the content of eFUSE memory block is transferred to the internal registers related to trimming functions to permit good behavior of the device itself. If, for any reason, the content of the trimming registers is modified, it is sufficient to use this bit to restore the correct values. When the BOOT bit is set to '1' the content of the internal eFUSE is copied inside the corresponding internal registers and is used to calibrate the device. These values are factory trimmed and are different for every device. They permit good behavior of the device and normally they should not be changed. At the end of the boot process, the BOOT bit is set again to '0'

The ONE_SHOT bit is used to start a new conversion. In this situation a single acquisition of temperature and humidity is started when the ONE_SHOT bit is set to '1'. At the end of conversion the new data are available in the output register, the STATUS_REG[0] and STATUS_REG[1] bits are set to '1' and the ONE_SHOT bit comes back to '0' by hardware.

CTRL_REG3

7	6	5	4	3	2	1	0
DA_H_L	PP_OD	Reserved			DA_EN	Reserved	

Table 20: CTRL_REG3

Address: 22h (R/W)
Description: Control register for data available output signal
[7] DA_H_L : Data available output signal active high, low
(0: active high –default, 1: active low)
[6] PP_OD: Push-pull / Open Drain selection on pin DA
(0: push-pull – default, 1: open drain)
[5:3] Reserved
[2] DA_EN: Data available enable
(0: Data available disabled – default, 1: Data available signal available on pin DA)
[1:0] Reserved

The DA_EN bit enables the DA signal on pin 9. Normally inactive, the DA output signal becomes active on new data available: logical OR of the bits STATUS_REG[1] and STAUTS_REG[0] for humidity and temperature, respectively. The DA signal returns inactive after both HUMIDITY_OUT_H and TEMP_OUT_H registers are read.

STATUS_REG

7	6	5	4	3	2	1	0
Reserved						H_DA	T_DA

Table 21: STATUS_REG

Address: 27h (R)
 Description: Status register; the content of this register is updated every one-shot reading, and after completion of every ODR cycle, regardless of BDU value in CTRL_REG1.
 [7:2] Reserved
 [1] H_DA: Humidity data available
 (0: new data for Humidity is not yet available, 1: new data for Humidity is available)
 [0] T_DA: Temperature data available
 (0: new data for temperature is not yet available, 1: new data for temperature is available)

H_DA is set to 1 whenever a new humidity sample is available. H_DA is cleared anytime HUMIDITY_OUT_H (29h) register is read.

T_DA is set to 1 whenever a new temperature sample is available. T_DA is cleared anytime TEMP_OUT_H (2Bh) register is read.

HUMIDITY_OUT_L

7	6	5	4	3	2	1	0
HOUT7	HOUT6	HOUT5	HOUT4	HOUT3	HOUT2	HOUT1	HOUT0

Table 22: HUMIDITY_OUT_L

Address: 28h (R)
 Description: Humidity data
 [7:0] HOUT7-HOUT0: Humidity data LSB

HUMIDITY_OUT_H

15	14	13	12	11	10	9	8
HOUT15	HOUT14	HOUT13	HOUT12	HOUT11	HOUT10	HOUT9	HOUT8

Table 23: HUMIDITY_OUT_H

Address: 29h (R)
 Description: Humidity data
 [7:0] HOUT15-HOUT8: Humidity data MSB

TEMP_OUT_L

7	6	5	4	3	2	1	0
TOUT7	TOUT6	TOUT5	TOUT4	TOUT3	TOUT2	TOUT1	TOUT0

Table 24: TEMP_OUT_L

Address: 2Ah (R)
 Description: Temperature data
 [7:0] TOUT7-TOUT0: Temperature data LSB

TEMP_OUT_H

15	14	13	12	11	10	9	8
TOUT15	TOUT14	TOUT13	TOUT12	TOUT11	TOUT10	TOUT9	TOUT8

Table 25: TEMP_OUT_H

Address: 2Bh (R)
Description: Temperature data
[7:0] TOUT15-TOUT8: Temperature data MSB

7.5. HUMIDITY AND TEMPERATURE DATA CONVERSION

With the relative humidity data output D_{RH} [= data of register address 29h, 28h] the relative humidity RH is obtained by the following formula (result in %RH), no matter which resolution is chosen:

$$RH = -6 + 125 \cdot \frac{D_{RH}}{2^{16}}$$

The temperature T is calculated by inserting temperature data output D_T [= data of register address 2B, 2A] into the following formula (result in °C), no matter which resolution is chosen:

$$T = -46.85 + 175.72 \cdot \frac{D_T}{2^{16}}$$

8. STAND-ALONE RELATIVE HUMIDITY OUTPUT

8.1. PWM OUTPUT

PWM signal runs on a base frequency of 120Hz, the data signal is provided on SDA line. By setting SEL[1:0] as '01', the PWM output mode is selected. SCL level setting '1' for humidity and '0' for temperature output mode is possible. The sensor measures twice per second. Output resolution of RH and Temperature are set to 10bit and 12 bit each.

PWM Specification

Pulse Width Modulation runs on a constant frequency and the measured information is provided as duty cycle on that frequency – see Figure 17.

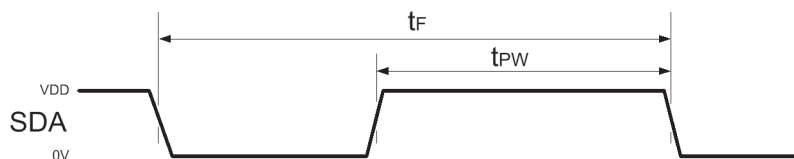

Figure 17: PWM signal. Base frequency runs constantly at approximately 120 Hz, hence t_F is about 8.3ms. The signal is provided on t_{PW} as a ratio of t_F .

The measured data – either humidity or temperature – is provided as ratio of t_{PW} and t_F . t_{PW} shall always be given as ratio of t_F to make it independent of variations of the base frequency.

Conversion of Signal Output

The sensor reading is linear and hence it can be converted to a physical value by an easy linear equation.

With the relative humidity signal output the relative humidity RH is obtained by the following formula (result in %RH):

$$RH = -6 + 125 \cdot \frac{t_{PW}}{t_F}$$

The physical value RH given above corresponds to the relative humidity above liquid water according to World Meteorological Organization (WMO).

The temperature T is calculated by inserting the ratio of t_{PW} and t_F into the following formula (result in °C):

$$T = -46.85 + 175.72 \cdot \frac{t_{PW}}{t_F}$$

8.2. PDM OUTPUT

PDM signal is a pulse sequence that with a low pass filter may be converted into analog voltage output. The data signal is provided on SDA line. By setting SEL[1:0] as '10', the PDM output mode is selected. Humidity and temperature output mode is selected by SCL level. The sensor measures twice per second. Output resolution of RH and Temperature are set to 10bit and 12 bit each.

PDM output

Pulse Density Modulation is a bit-stream of pulses; the more high pulses the higher the value in the full measurement range – see Figure 18.

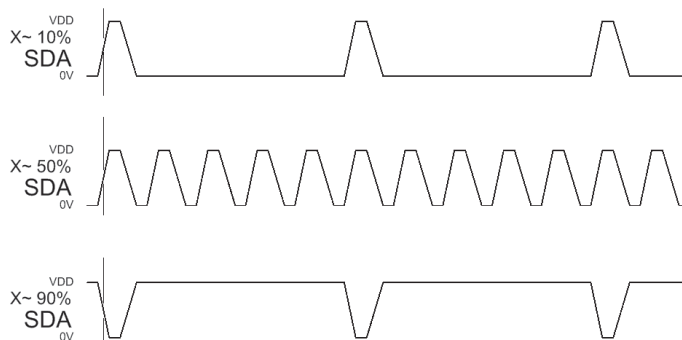

Figure 18: Schematic principle of PDM signal. X represents either RH or T at different levels of sensor output.

Converting PDM to Analogue Signal

A PDM signal normally is converted to an analogue voltage signal by the addition of a low-pass filter. Figure 19 displays a typical circuit where a simple RC-filter is used.

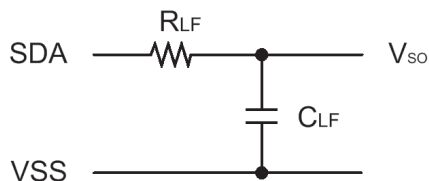

Figure 19: Typical circuit with low pass filter (surrounded by hatched line) for analog output. Recommended component size: RLP = 100kΩ and CLP = 220nF. By pulling SCL low or high, the output value is switched to temperature or humidity, respectively.

For an acceptable small ripple of the analog voltage signal, a cut-off frequency of 7 Hz is recommended. Typical values for the low pass filter components are R = 100 kΩ and C = 220 nF. The corresponding ripple of the signal is limited to maximal amplitude of ±0.2 % RH and ±0.28 °C, respectively. If larger deviations are acceptable the capacitor size can be reduced.

Important: The maximum current from SDA should not exceed 40 μA. Therefore, there are restrictions on the size of the resistance RLP. Furthermore, the current should be kept as low as possible and therefore the input impedance of the reading buffer shall be larger than 50 MΩ (60 nA input biased current). Eventually, cable length between sensor and low pass filter shall be kept as short as possible in order to prevent self-heating.

Please note, that ripples and impacts by impedance are not considered in the accuracy statement.

Conversion of Signal Output

After the low pass filter the sensor provides an output Voltage V_{SO} which as a portion of V_{DD} then is converted into a physical value.

Resolution is set to 10 bit for relative humidity and 12 bit for temperature and cannot be changed. The sensor reading is linearized and hence it can be converted to a physical value by an easy linear equation.

With the relative humidity signal output the relative humidity RH is obtained by the following formula (result in %RH):

$$RH = -6 + 125 \cdot \frac{V_{SO}}{V_{DD}}$$

The physical value RH given above corresponds to the relative humidity above liquid water according to World Meteorological Organization (WMO).

The temperature T is calculated by inserting temperature signal output ST into the following formula (result in °C):

$$T = -46.85 + 175.72 \cdot \frac{V_{SO}}{V_{DD}}$$

9. APPLICATIONS

9.1. STORAGE INSTRUCTION

Moisture Sensitivity Level (MSL) is 1, according to IPC/JEDEC J-STD-020. At the same time, it is recommended to further process the sensors within 1 year after date of delivery.

It is of great importance to understand that a humidity sensor is not a normal electronic component and needs to be handled with care. Chemical vapors at high concentration in combination with long exposure times may offset the sensor reading.

For this reason it is recommended to store the sensors in original packaging including the sealed ESD bag at following conditions: Temperature shall be in the range of 10°C – 50°C and humidity at 20 – 60%RH (sensors that are not stored in ESD bags).

9.2. SOLDERING INSTRUCTIONS

For soldering, a lead-free, air-, and nitrogen-reflow-solderable no-clean type 3 solder paste, which meets the requirements of the RoHS Directive 2002/95/EC Art. 4, as well as the standards by J-STD-004, is recommended. For further guide regarding soldering and assembling, please refer to Application Note.

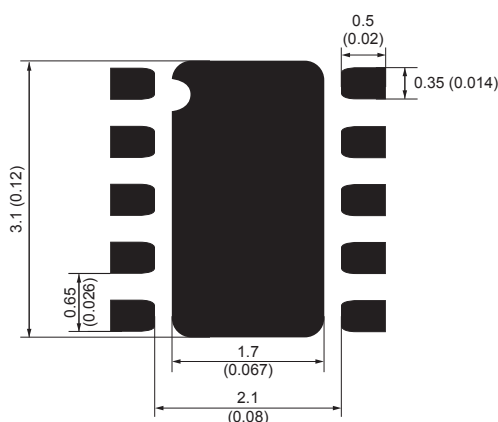

Figure 20: Metal Land pattern

9.3. POST REFLOW TREATMENT

We strongly recommend high humidity storage of the boards including the sensor packages after reflow soldering. 8hours at 70±5 °C, 75±5%RH or 24 hours at 80±10%RH (room temperature) is advisable. Calibration or testing should be done after a short further rest (>1 hour) at room conditions.

9.4. HANDLING INFORMATION

During the whole transportation process it should be avoided to expose the sensor to high concentrations of chemical solvents for longer time periods. Otherwise the “Reconditioning procedure (9.4)” must be followed.

9.5. RECONDITIONING PROCEDURE

After exposure to extreme conditions or chemical solvents or storage time of several months, the sensor characteristic curve may offset. Exposure to higher temperature will reset the contamination offset (reflow soldering process or e.g. 110°C, 5-7h). When the parts come back to room temperature a humidity exposure to 70±5°C, 75±5% RH for 8 hours completes the reconditioning process.

9.6. TEMPERATURE EFFECTS

Relative humidity strongly depends on temperature. Therefore, it is essential to keep humidity sensors at the same temperature as the air of which the relative humidity is to be measured. In case of testing or qualification the reference sensor and test sensor must show equal temperature to allow for comparing humidity readings.

If the sensor shares a PCB with electronic components that produce heat it should be mounted in a way that prevents heat transfer or keeps it as low as possible.

Furthermore, there are self-heating effects in case the measurement frequency is too high. To keep self-heating below 0.1°C, EEH210 should not be active for more than 10% of the time – e.g. maximum two measurements per second at 12bit accuracy shall be made.

9.7. LIGHT

The EEH210 is not light sensitive but direct exposure to sunshine or strong UV radiation may age the sensor.

9.8. FORBIDDEN PACKAGING MATERIALS

Significant concentrations of chemical vapors and long exposure times can influence the characteristic of the sensor. Outgassing of certain packaging materials in a constant volume such as foams (e.g.: Type MOS 2200) glues, adhesive tapes and foils are strictly forbidden and may change the characteristic of the sensor.

9.9. WIRING AND SIGNAL INTEGRITY

When this EEH210 is used under I²C mode, carrying the SCL and SDA signal parallel and in close proximity (e.g. in wires) for more than 10cm may result in cross talk and loss of communication. Furthermore, slowing down SCL frequency will possibly improve signal integrity.

Under analog output modes, the output pin has to be protected from external noise source to get stable output. Power supply pins (V_{DD}, V_{SS}) must be decoupled with a 100 nF capacitor.

10. DOCUMENT REVISION HISTORY

DATE	R-PAGE	REVISED CONTENTS	TOTAL PAGE	REV. NO.
11 April 2016	-	Initial release	18	v1.0