



Intelligent Alarms



822A Dual Alarm

Thermocouple and Millivolt Input

Models

822A-0200:
Dual input alarm with two SPDT relays

Input Ranges

TC types: J, K, T, R, S, E, B, N
Millivolt: $\pm 15.625\text{mV}$ to $\pm 1.0\text{V DC}$

Alarm Outputs

Dual SPDT electro-mechanical 5A relays

Power Requirement

10 to 36V DC

Approvals

UL, cUL listed

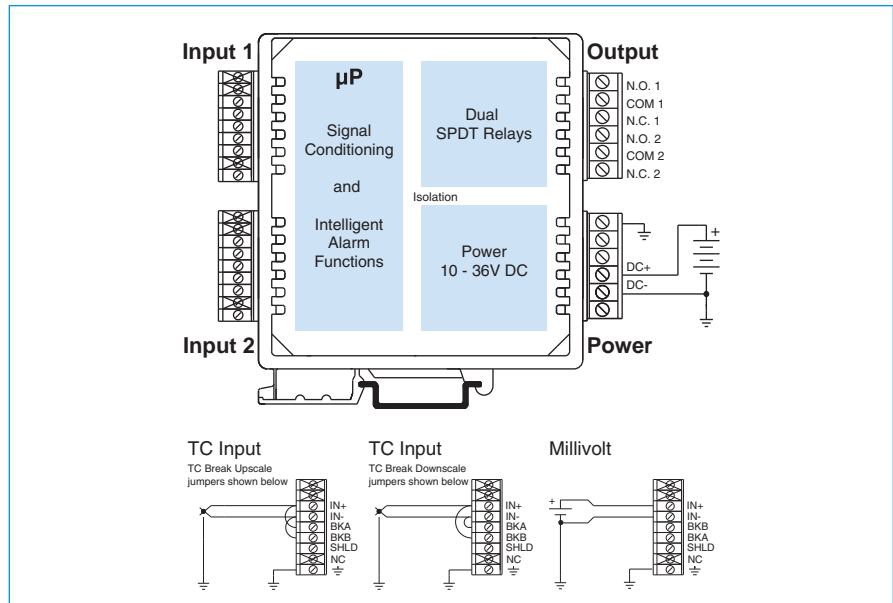

Description

IntelliPack alarms compare inputs against user-defined limit setpoints to control built-in relays.

Each unit offers a selection of input ranges and alarm functions to handle a broad range of applications. As your needs change, you can easily reconfigure the unit for different ranges or functions. Alarm functions available on all mod-els include on/off controller, limit alarm, window alarm, deviation alarm, rate-of-change alarm, and peak/valley detection.

Setup is very easy. IntelliPack alarms are configured through a user-friendly Windows 95/98/ME/NT/XP/2000 program. Field adjustments and recalibration are quickly performed with front-panel push-buttons and status LEDs. Once configured, IntelliPacks operate independent of any host computer.

Special Features

- Integrated microcontroller performs intelligent signal processing for advanced alarm functions.
- Windows XP/Vista/7 software configuration speeds setup and replacement.
- Push-button reprogrammability facilitates changes in the field without a host PC.
- Multi-purpose inputs accept numerous ranges to reduce spare stock requirements.
- High-resolution Sigma-Delta A/D converter delivers high accuracy with low noise.
- Input excitation supply on each input provides power for a two-wire transmitter.
- Dual alarm operation lets you perform two alarm functions at the same time.



■ Performance

■ General Input

Analog to Digital (A/D) Converter
16-bit Σ - Δ A/D converter.

Resolution
 $\pm 0.005\%$ of span or $0.1^\circ\text{C}/\text{LSB}$. ADC typically yields resolutions finer than $0.1^\circ\text{C}/\text{LSB}$.

Ambient Temperature Effect
Better than $\pm 0.005\%$ of input span per $^\circ\text{C}$ or $\pm 1\mu\text{V}$, whichever is greater.

Noise Rejection
Normal Mode: Better than 40dB @ 60Hz.
Common Mode: Better than 130dB @ 60Hz.

Input Filter
Normal mode filtering, plus digital filtering optimized and fixed per input range within Σ - Δ ADC.

Input Response Time
Less than 500mS to 98% of final value for a step change in the input. A software programmable delay can be implemented for filtering transients.

Relay Time Delay
Adjustable alarm delay of up to 25 seconds.

Input Overvoltage Protection
Bipolar Transient Voltage Suppressors (TVS).

■ Thermocouple Input

Thermocouple Input Ranges
Thermocouple type user configured. Signal linearization, cold-junction compensation, and open circuit or lead break detection are included.

TC	$^\circ\text{C}$ Range ($^\circ\text{F}$ Range)	Accuracy
J	-210 to 760 $^\circ\text{C}$ (-346 to 1400 $^\circ\text{F}$)	$\pm 0.5^\circ\text{C}$
K	-200 to 1372 $^\circ\text{C}$ (-328 to 2502 $^\circ\text{F}$)	$\pm 0.5^\circ\text{C}$
T	-260 to 400 $^\circ\text{C}$ (-436 to 752 $^\circ\text{F}$)	$\pm 0.5^\circ\text{C}$
R	-50 to 1768 $^\circ\text{C}$ (-58 to 3214 $^\circ\text{F}$)	$\pm 1.0^\circ\text{C}$
S	-50 to 1768 $^\circ\text{C}$ (-58 to 3214 $^\circ\text{F}$)	$\pm 1.0^\circ\text{C}$
E	-200 to 1000 $^\circ\text{C}$ (-328 to 1832 $^\circ\text{F}$)	$\pm 0.5^\circ\text{C}$
B	260 to 1820 $^\circ\text{C}$ (500 to 3308 $^\circ\text{F}$)	$\pm 1.0^\circ\text{C}$
N	-230 to 1300 $^\circ\text{C}$ (-382 to 2372 $^\circ\text{F}$)	$\pm 0.5^\circ\text{C}$

Thermocouple Break Detection
Upscale or downscale.

■ DC Millivolt Input

DC Millivolt/Voltage Input Ranges

$\pm 1.0\text{V}$	$\pm 125\text{mV}$	$\pm 31.25\text{mV}$
$\pm 500\text{mV}$	$\pm 62.5\text{mV}$	$\pm 15.625\text{mV}$
$\pm 250\text{mV}$		

Millivolt Accuracy
Better than $\pm 0.05\%$ of input span.

■ Output

Relays
Two independent SPDT electro-mechanical relays.
Contact material Silver-Cadmium Oxide (AgCdO).

Relay Ratings (CSA ratings)
25V DC @ 5A.
120/240V AC @ 5A.

Expected Mechanical Life
20 million operations.

■ Environmental

Ambient Temperature
Operating: -25 to 70°C (-13 to 158°F).
Storage: -40 to 85°C (-40 to 185°F).

Relative Humidity
5 to 95%.

Power Requirements
10 to 36V DC. 60mA @ 24V. 90mA @ 15V.

Isolation
3-way (input/output/power).
1500V AC for 60 seconds or 250V AC continuous.
Inputs are isolated (up to 48V) from each other.

Radiated Field Immunity (RFI)
EN61000-4-3, EN50082-1

Electromagnetic Field Immunity (EMI)
No relay trips will occur beyond $\pm 0.25\%$ of input span from setpoint under the influence of electromagnetic fields from switching solenoids, commutator motors, and drill motors.

Electrical Fast Transient (EFT)
EN61000-4-4, EN50082-1.

Surge Withstanding Capability (SWC)
EN61000-4-5, EN50082-1.

Electrostatic Discharge (ESD)
EN61000-4-2, EN50082-1.

Radiated Emissions
EN50081-1 for Class B equipment.

Approvals
UL, cUL listed (USA, Canada).
UL3121 - general product safety.

■ Configuration

Software Configuration
Units are fully programmable via the Windows XP/Vista/7 IntelliPack Configuration Program. Configuration downloads from PC through EIA232 serial port using Acromag 800C-SIP kit.

Field Configuration
Setpoint and deadband are configurable via push-buttons and a standard calibrator.

LED Indicators
LEDs indicate power, status, and alarm.

■ Physical

Enclosure
Case: Self-extinguishing NYLON type 6.6 polyamide thermoplastic UL94 V-2, color beige; general purpose NEMA Type 1 enclosure.

Connectors (Removable terminal blocks)
Wire Range: AWG #14-22 (AWG #12 stranded only).

Printed Circuit Boards
Military grade FR-4 epoxy glass circuit board.

Dimensions
1.05W x 4.68H x 4.35D inches.
26.7W x 118.9H x 110.5D millimeters.

Shipping Weight
1 pound (0.45 Kg) packed.

■ Ordering Information

IMPORTANT: All IntelliPacks require initial software configuration (order 800C-SIP). See Note 1 below.

822A-0200
IntelliPack alarm unit.
Two thermocouple/millivolt inputs, two SPDT relays.

800C-SIP
Software Interface Package.
Only one kit is required for all IntelliPack models.

4001-095
USB-to-Serial adapter (Windows® 7 and newer)

PSSR-VD24
Power supply (24V DC, 2.1A)

TBK-B01
Optional terminal block kit, barrier strip style, 2 pcs. (Does not include terminal block for input wiring.)

TBK-S01
Optional terminal block kit, spring clamp style, 2 pcs. (Does not include terminal block for input wiring.)

NOTE 1: To order factory configuration, call Acromag for a configuration form which must accompany your order. Also, append "-C" to model number (example: 822A-0200-C). 800C-SIP kit is still recommended.



Optional terminal blocks: barrier strip (left) and spring clamp (right). Cage clamp terminal is standard.



Dimensions

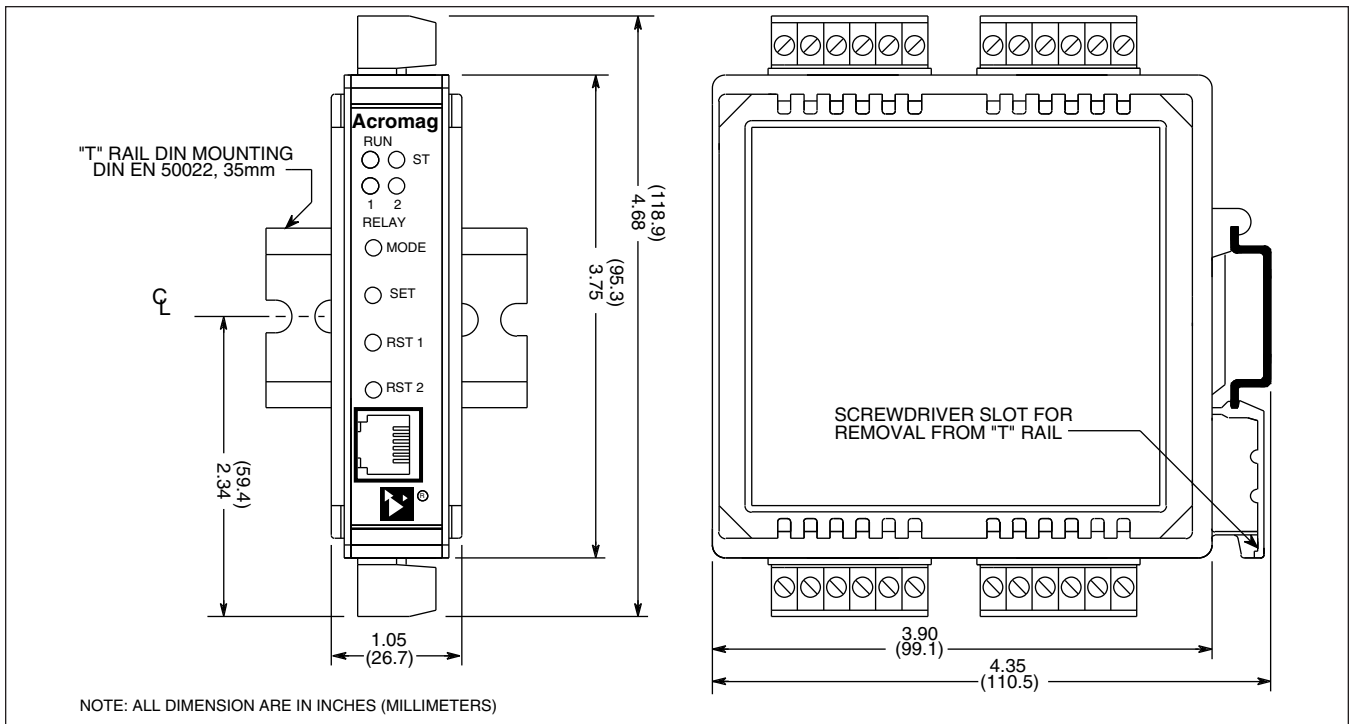



Accessories

Terminal Blocks

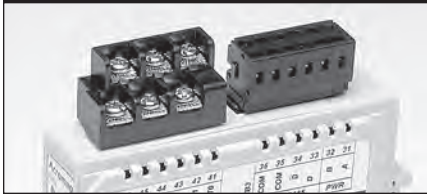

Barrier strip (left) and spring clamp (right).

Ordering Information

See individual I/O modules for compatibility.

Barrier Strip Terminal Blocks

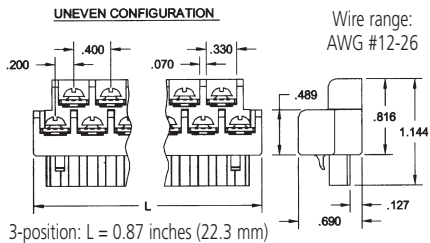
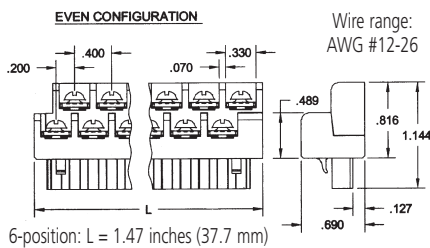

TBK-B01
Terminal block kit,
two 6-position pieces

TBK-B03
Terminal block kit,
one 3-position and
three 6-position pieces

TBK-B02
Terminal block kit,
four 6-position pieces

Spring Clamp Terminal Blocks

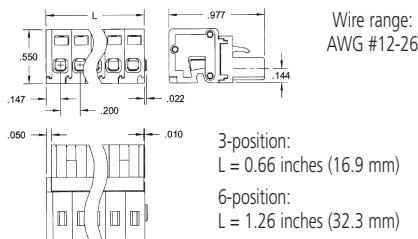

TBK-S01
Terminal block kit,
two 6-position pieces

TBK-S03
Terminal block kit,
one 3-position and
three 6-position pieces

TBK-S02
Terminal block kit,
four 6-position pieces

Mounting Hardware



DIN-Rail Mounting

For your convenience, Acromag offers several mounting accessories to simplify your system installation. Our 19" rack-mount kit provides a clean solution for mounting your I/O modules and a power supply. Or you can buy precut DIN rail strips for mounting on any flat surface.

Ordering Information

20RM-16-DIN: 19" rack-mount kit with DIN rail.

DIN RAIL 3.0
DIN RAIL 16.7

DIN rail strip, Type T, 3 inches (75mm) or 16.7 inches (425mm)

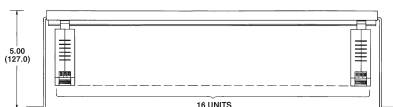
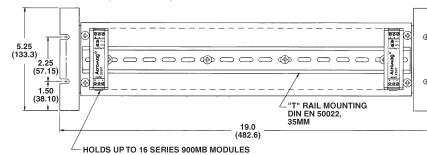

Power Supplies

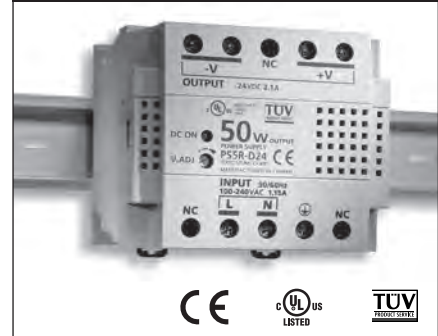

50W Supply

Input Power Requirement
85 to 264V AC or 105 to 370V DC

Output
24V DC, 2.1A (50W)

Ordering Information

PS5R-VD24: Universal 50W power supply

USB to Serial Adapter



Data Rate: Up to 115.2Kbps
RoHS-compliant
PC Requirements:
Windows® 7 and newer

Ordering Information

4001-095: USB-to-Serial adapter

AC Current Sensor

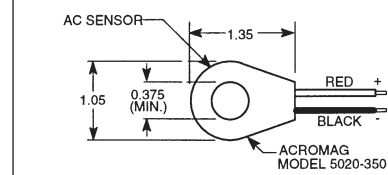

Ordering Information

5020-350: AC current sensor

IntelliPack®: 800 Series

IntelliPack 800 Series Signal Conditioners

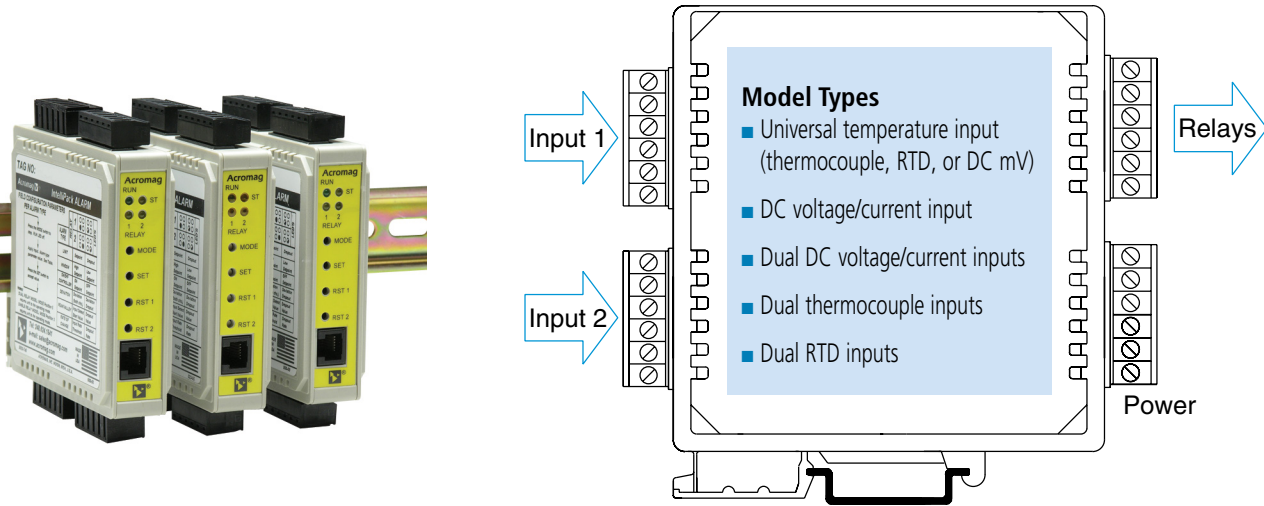

Universal Temperature Input ◆ DC Voltage/current Input ◆ Thermocouple Input ◆ RTD Input

800A Models

Single input models

801A: Universal temperature input (thermocouple, RTD, or DC millivolts); One DPDT relay or two SPDT relays

811A: DC voltage/current* input; One DPDT relay or two SPDT relays

Dual input models

812A: DC volt./current* inputs; Two SPDT relays

822A: Thermocouple inputs; Two SPDT relays

832A: RTD inputs; Two SPDT relays

* AC current sensor option available. IntelliPack alarms compare inputs against user-defined limit setpoints to control built-in relays.

Each unit offers a selection of input ranges and alarm functions to handle a broad range of applications. As your needs change, you can easily reconfigure the unit for different ranges or functions. Alarm functions available on all models include on/off controller, limit alarm, window alarm, deviation alarm, rate-of-change alarm, and peak/valley detection. Other functions are also possible; please consult the factory.

Setup is very easy. IntelliPack alarms are configured through a user-friendly Windows XP/Vista/7 program. Field adjustments and recalibration are quickly performed with front-panel push-buttons and status LEDs. Once configured, IntelliPacks operate independent of any host computer.

Key Features & Benefits

General Operation

- Advanced microcontroller has integrated, downloadable flash memory and EEPROM for intelligent signal processing.
- Windows XP/Vista/7 software configuration speeds setup and replacement.
- Push-button reprogrammability facilitates changes in the field without a host PC.
- Plug-in terminal blocks make module installation and removal easy.
- Built-in self-diagnostic routines operate upon power-up and during operation for easy maintenance and troubleshooting.
- 3-way isolation separates inputs, power, and relay contacts from each other.
- EMC compliant. Ruggedized circuitry meets directives to provide increased transient immunity and low emissions.
- Wide ambient temperature range ensures reliable performance from -25 to 70°C.
- Wide DC supply range with diode-coupled reverse polarity protection is useful for redundant supplies and battery backup.

Alarm Operation

- Multi-purpose inputs accept numerous ranges to reduce spare stock requirements.

- User-programmable alarm operation lets you select or change alarm functions (see next page for supported functions).
- Dual alarm operation lets you perform two alarm functions at the same time.
- High-resolution Sigma-Delta A/D converter delivers high accuracy with low noise.
- Input excitation supply on each input provides power for a two-wire transmitter.
- High-power relays switch voltages up to 230V AC at 5A.
- User-programmable deadband (100%) on each setpoint eliminates relay chatter and prolongs contact life.
- User-programmable relay reset enables automatic alarm reset or latching alarm with manual reset.
- Failsafe/non-failsafe operation lets you set the default relay position.
- Relay delay feature lets you set the reaction time to filter transients.
- Thermocouple and RTD signal processing performs linearization, up/downscale break detection, reference-junction compensation and other functions.



Tel: 248-295-0880 ■ sales@acromag.com ■ www.acromag.com ■ 30765 S Wixom Rd, Wixom, MI 48393 USA



Alarm Functions

Each IntelliPack alarm unit includes all the alarm functions listed below. Acromag's configuration software helps you quickly define or modify the relay operation for your application. Unique, fill-in-the-blank screens are provided for each alarm type.

Limit Alarm

Limit alarms monitor a single setpoint (high or low) for an alarm condition. The relay enters the alarm state when the input signal exceeds the setpoint for a user-defined time period. This time period helps filter input transients. The relay remains in the alarm state until the input signal retreats past the setpoint and any applied deadband.

Window (Band-Pass) Alarm

Window alarms use two setpoints to monitor for an alarm condition. This allows both a high and low setpoint to be defined for a single input signal. The two setpoints define a minimum/maximum operating range or a window. This function is commonly referred to as a Window, Guard, or Band-Pass alarm.

The relay enters the alarm state when the input level rises or falls outside the window for a user-defined time period (to filter input transients). The relay remains in the alarm state until the input retreats back into the window, plus any applied deadband.

On/Off Controller

An on/off controller uses two setpoints to toggle a relay. No deadband is applied. This alarm type is often used for level control applications, such as filling or emptying a container (pump/valve control).

The relay enters the alarm state when the input exceeds the "on" setpoint for a user-defined time period. The relay remains in the alarm state until the input signal retreats past the "off" setpoint.

Deviation Alarm (Dual Input Models Only)

The deviation alarm generates an alarm condition based on the difference between two input signals. One signal serves as the reference input. The second input signal is monitored for a user-defined deviation value (positive, negative, or absolute) with respect to the reference input.

This alarm type is useful for controlling temperature and flow.

The relay enters the alarm state when the deviation exceeds the limit for a user-defined time period. The relay remains in the alarm state until the deviation decreases below the limit, plus any applied deadband.

Peak/Valley Detection Alarm

This function detects when the input signal reaches a maximum (peak) or minimum (valley) value. Peak/valley alarms are useful for torque and pressure testing applications as well as for monitoring temperature and chemical reactions.

The detection function activates only after the input exceeds a user-defined threshold level. Once activated, the alarm unit monitors the input signal for a decrease on a rising signal or an increase on a falling signal. A relay trips when the signal exceeds a user-defined deadband following the peak/valley. The relay remains in alarm state until the signal reaches a user-defined dropout value.

Rate-of-Change

This function monitors an input for a change in value with respect to time. IntelliPacks monitor absolute rate-of-change and can activate for increasing or decreasing rates.

The relay enters alarm state when the input rate-of-change exceeds the user-defined rate limit for a one second time period. The relay remains in the alarm state until the rate-of-change moves past a specified dropout level for a one second time period.

Other Alarm Functions

Internal intelligence and downloadable flash memory allow IntelliPacks to perform many other functions. If your application differs from the standard alarms above, please call the factory regarding the possibility of other functions custom-tailored to your needs.

Limit Alarm

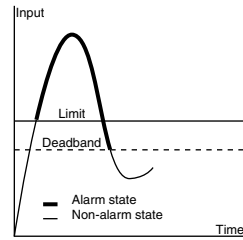

Window Alarm

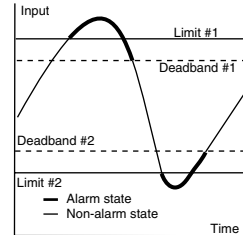

On/Off Controller

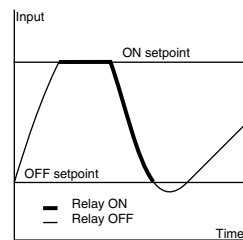

Deviation Alarm

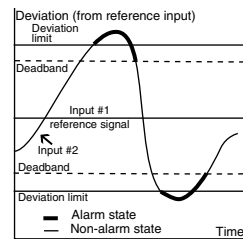

Peak/valley Detector

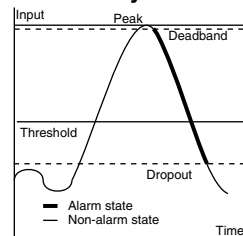

Rate of Change Alarm

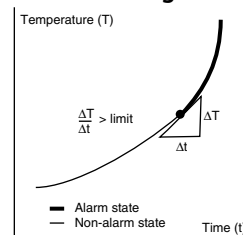

IntelliPack®: 800 Series

IntelliPack 800 Series Signal Conditioners



Software Configuration Examples

Limit Alarms, Window Alarms, and On/Off Controllers

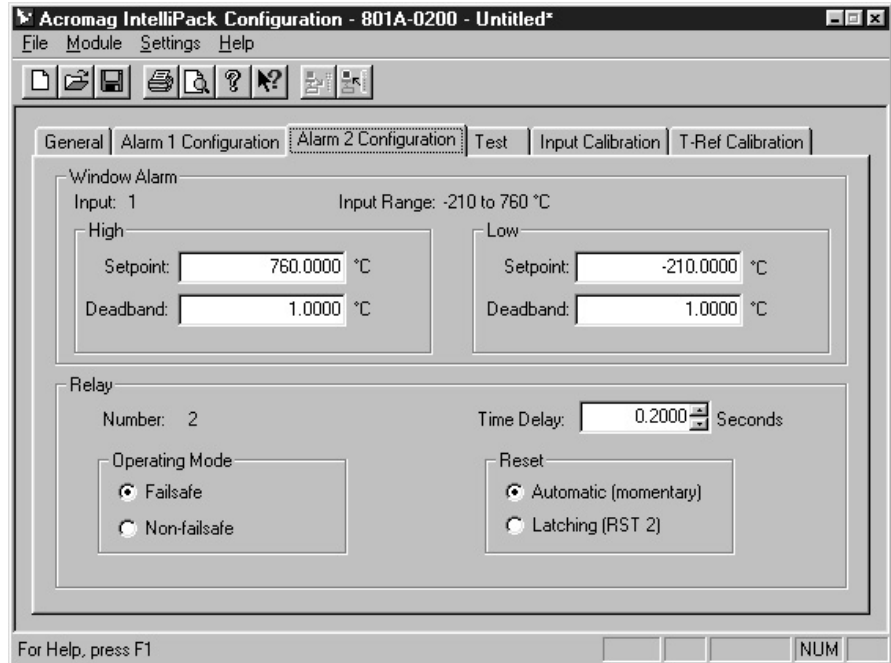

A property sheet to configure a window alarm. Limit alarms and on/off controllers are similar. Typical applications: pump control, early warning alert, safety shutdown.

Deviation Alarms

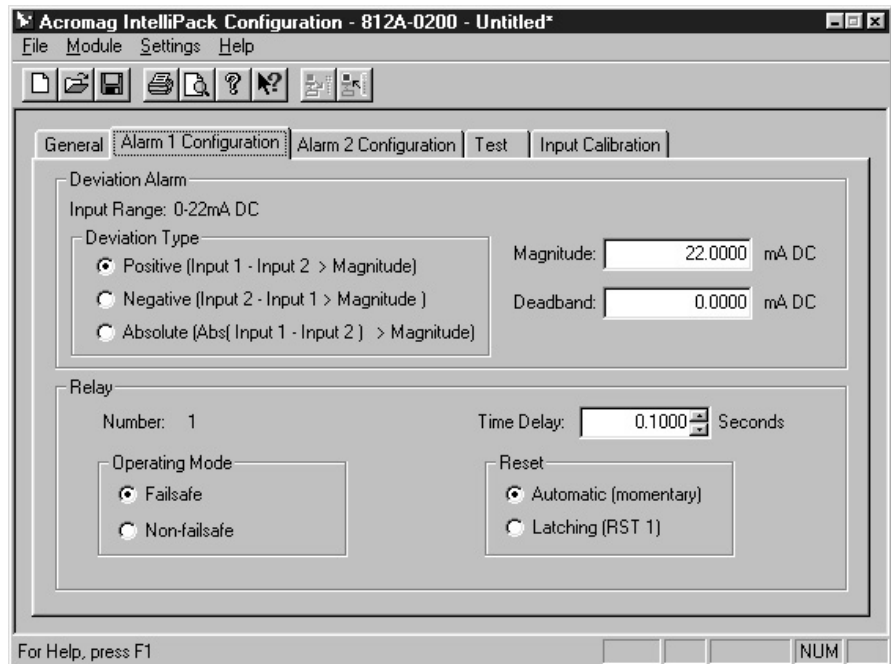

A property sheet to configure a deviation alarm. Positive, negative, and absolute deviation alarms are supported. Typical applications: speed tracking/monitoring, consistent batch temperature measurement, flow leak detection.



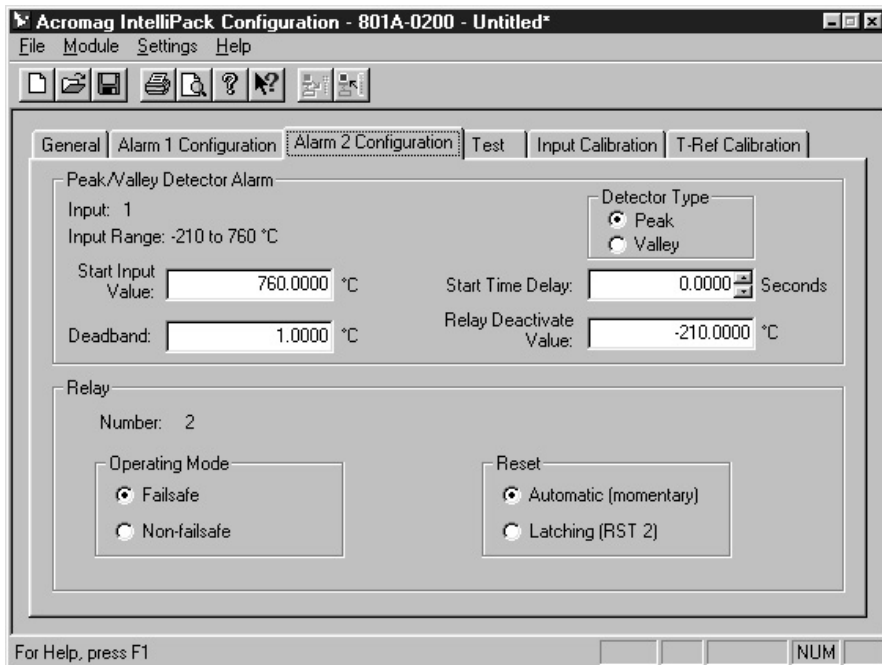

Peak/Valley Alarms

A property sheet to configure a peak/valley alarm. Typical applications: force measurement, pressure testing, chemical mixing.

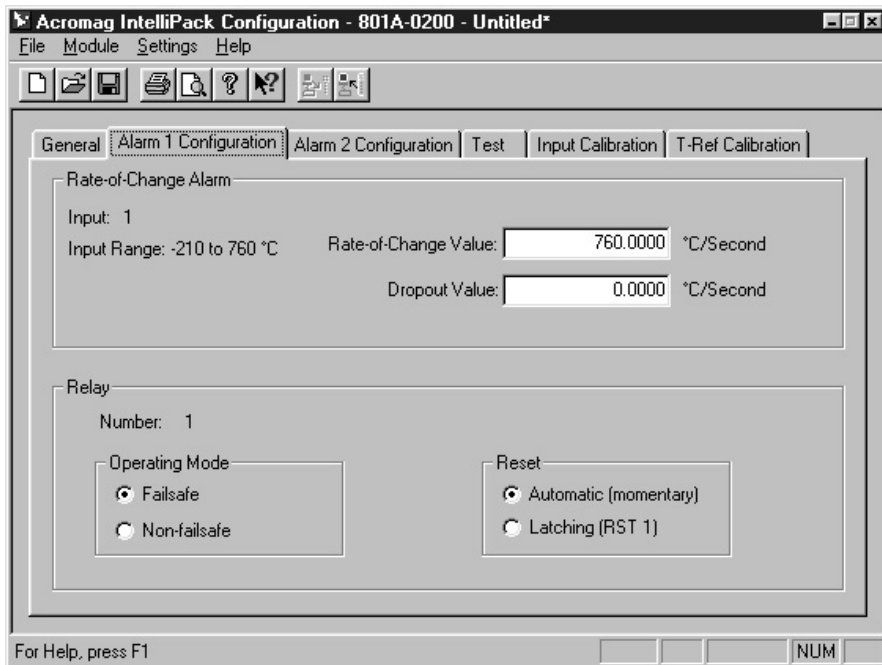

Rate-of-Change Alarms

A property sheet to configure a rate-of-change alarm. Typical applications: injection molding, speed sensing, monitoring chemical reactions