

Precision High SNR Zero-Height SiSonic™ Microphone

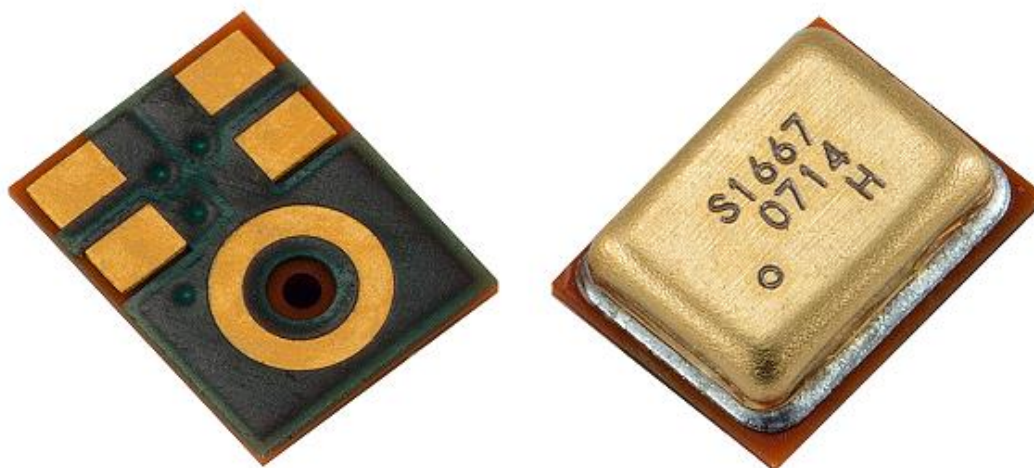

The SPH1611LR5H-1 is a miniature, high-performance, low power, bottom port silicon microphone. Using Knowles' proven high performance SiSonic™ MEMS technology, the SPH1611LR5H-1 consists of an acoustic sensor, a low noise input buffer, and an output amplifier. These devices are suitable for applications such as cellphones, smart phones, laptop computers, sensors, digital still cameras, portable music recorders, and other portable electronic devices where excellent wideband audio performance and RF immunity are required.

Features:

- Matched Sensitivity
- High SNR
- Small package
- Flat Frequency Response
- MaxRF protection
- Zero-Height Mic™
- Ultra-Stable Performance
- Standard SMD Reflow
- Omnidirectional

1. ABSOLUTE MAXIMUM RATINGS

Parameter	Absolute Maximum Rating	Units
V _{DD} to Ground	-0.5, +5.0	V
OUT to Ground	-0.3, V _{DD} + 0.3	V
Input Current to Any Pin	±5	mA
Temperature Range	-40 to +100	°C

Stresses exceeding these “Absolute Maximum Ratings” may cause permanent damage to the device. These are stress ratings only. Functional operation at these or any other conditions beyond those indicated under “Acoustic & Electrical Specifications” is not implied. Exposure beyond those indicated under “Acoustic & Electrical Specifications” for extended periods may affect device reliability.

2. ACOUSTIC & ELECTRICAL SPECIFICATIONS

TEST CONDITIONS: 23 ±2°C, 55±20% R.H., V_{DD}(min) < V_{DD} < V_{DD}(max), no load, unless otherwise indicated

Parameter	Symbol	Conditions	Min	Typ	Max	Units
Supply Voltage ¹	V _{DD}		1.5	-	3.6	V
Supply Current ^{1,2}	I _{DD}		-	145	185	μA
Sensitivity ¹	S	94 dB SPL @ 1 kHz	-39	-38	-37	dBV/Pa
Signal to Noise Ratio	SNR	94 dB SPL @ 1 kHz, A-weighted	-	65	-	dB(A)
Total Harmonic Distortion	THD	94 dB SPL @ 1 kHz, S = Typ, R _{load} > 2 kΩ	-	0.2	0.3	%
Acoustic Overload Point	AOP	10% THD @ 1 kHz, S = Typ, V _{DD} = 3.6V, R _{load} > 2 kΩ	122	124	-	dB SPL
Power Supply Rejection Ratio	PSRR	200mVpp sinewave @ 1 kHz, V _{DD} = 1.8V	-	60	-	dB
Power Supply Rejection	PSR	100 mVpp square wave @ 217 Hz, V _{DD} = 1.8V, A-weighted	-	-92	-	dBV(A)
DC Output		V _{DD} = 1.5V	-	1.10	-	V
Output Impedance	Z _{OUT}	@ 1 kHz	-	-	400	Ω
Directivity			Omnidirectional			
Polarity		Increasing sound pressure	Increasing output voltage			

¹ 100% tested.

² Maximum specifications are measured at maximum V_{DD}. Typical specifications are measured at V_{DD} = 1.8V.

3. FREQUENCY RESPONSE CURVE

Typical Free Field Response
Normalized to 1 kHz

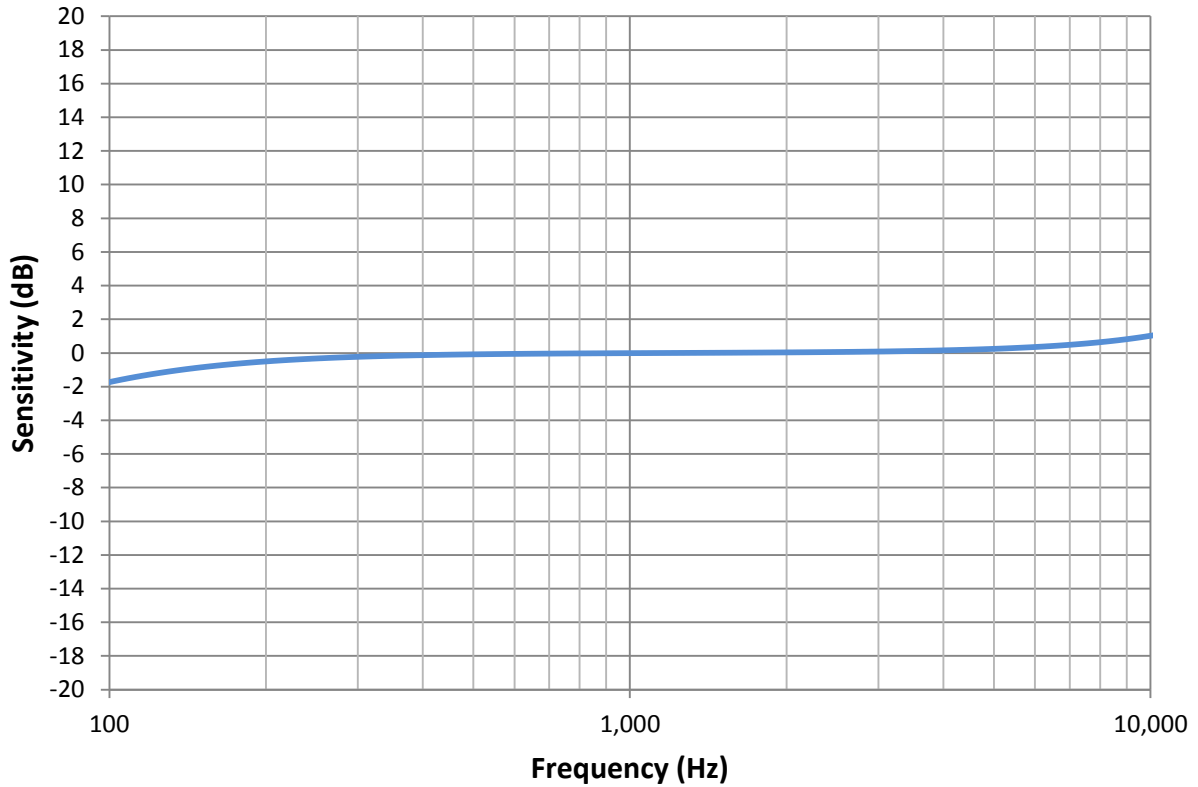

4. INTERFACE CIRCUIT

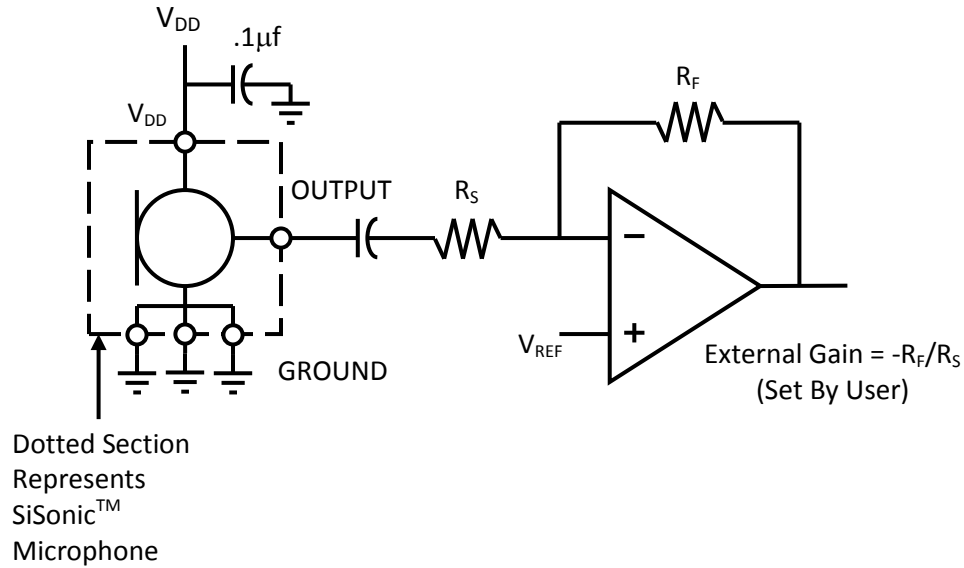

Notes: All Ground pins must be connected to ground.

Capacitors near the microphone should not contain Class 2 dielectrics.

Detailed information on acoustic, mechanical, and system integration can be found in the latest *SiSonic™ Design Guide* application note.

5. MECHANICAL SPECIFICATIONS

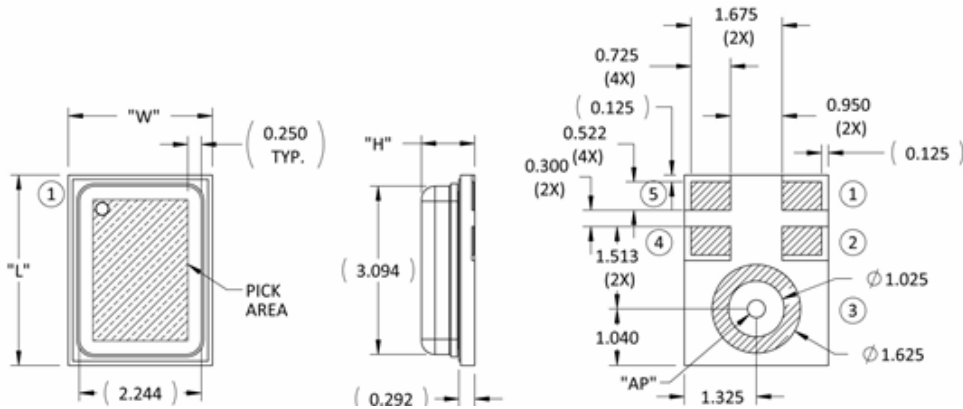

Item	Dimension	Tolerance
Length (L)	3.50	±0.10
Width (W)	2.65	±0.10
Height (H)	0.98	±0.10
Acoustic Port (AP)	∅0.325	±0.05

Pin #	Pin Name	Type	Description
1	OUTPUT	Signal	Output Signal
2	GROUND	Power	Ground
3	GROUND	Power	Ground
4	GROUND	Power	Ground
5	V _{DD}	Power	Power Supply

EXAMPLE LAND PATTERN

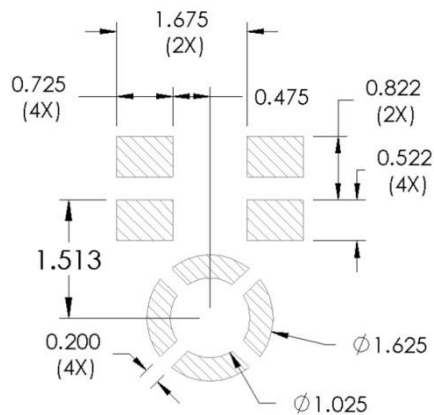

EXAMPLE SOLDER STENCIL PATTERN

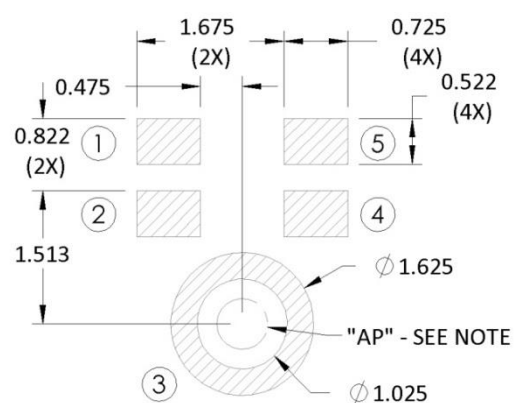

Notes: Pick Area only extends to 0.25 mm of any edge or hole unless otherwise specified.

Dimensions are in millimeters unless otherwise specified.

Tolerance is ±0.15mm unless otherwise specified

In the acoustic path, the recommended PCB hole Diameter is $\varnothing 0.65 < \text{PCB Hole} < \varnothing 1$, recommended Gasket Cavity Diameter is $D \geq 1.0\text{mm}$; and recommended Case Hole Diameter is $1.0\text{mm} < D < 1.5\text{mm}$. More

information on AP size considerations can be found in the latest SiSonic™ Design Guide application note

Further optimizations based on application should be performed.

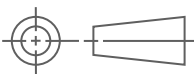

6. PACKAGING & MARKING DETAIL

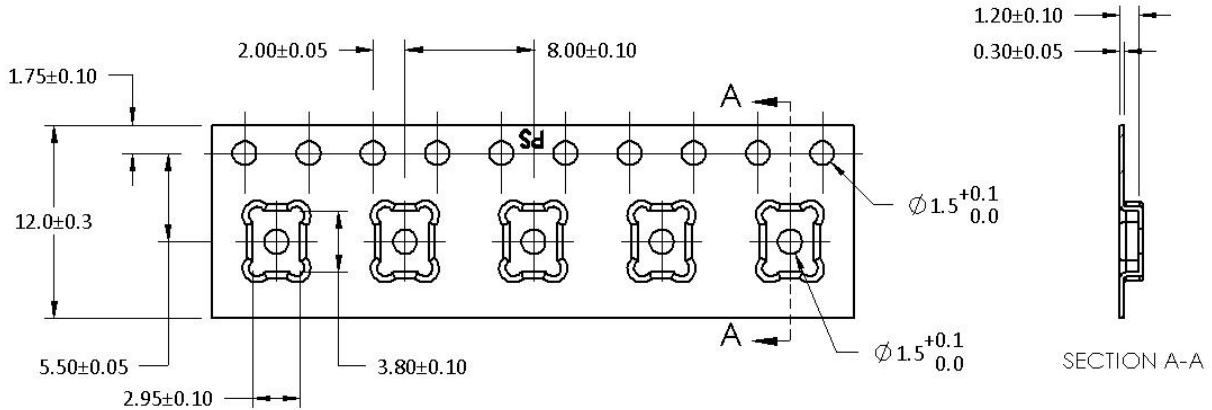

Model Number	Suffix	Reel Diameter	Quantity Per Reel
SPH1611LR5H-1	-8	13"	5,900

Alpha Character A:

“S”: Knowles SiSonic™ Production

“E”: Knowles Engineering Samples

“P”: Knowles Prototype Samples

“JIN NUMBER”:

Unique Job Identification Number
for product traceability

“H”

“Unique Identifier for this Model”

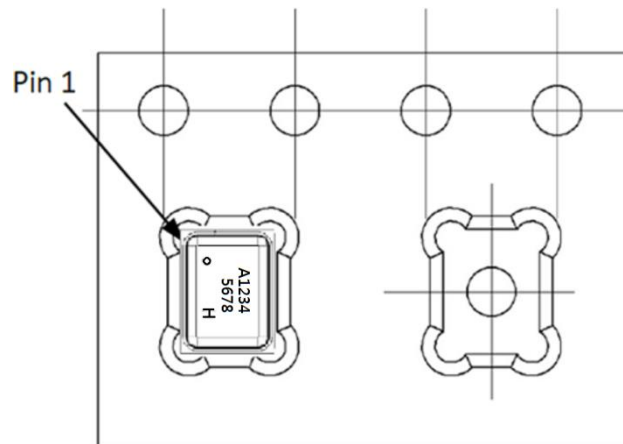

Notes: Dimensions are in millimeters unless otherwise specified.

Vacuum pickup only in the pick area indicated in Mechanical Specifications.

Tape & reel per EIA-481 “REV C”.

Labels applied directly to reel and external package.

Shelf life: Twelve (12) months when devices are to be stored in factory supplied,
unopened ESD moisture sensitive bag under maximum environmental conditions of
30°C, 70% R.H.

7. RECOMMENDED REFLOW PROFILE

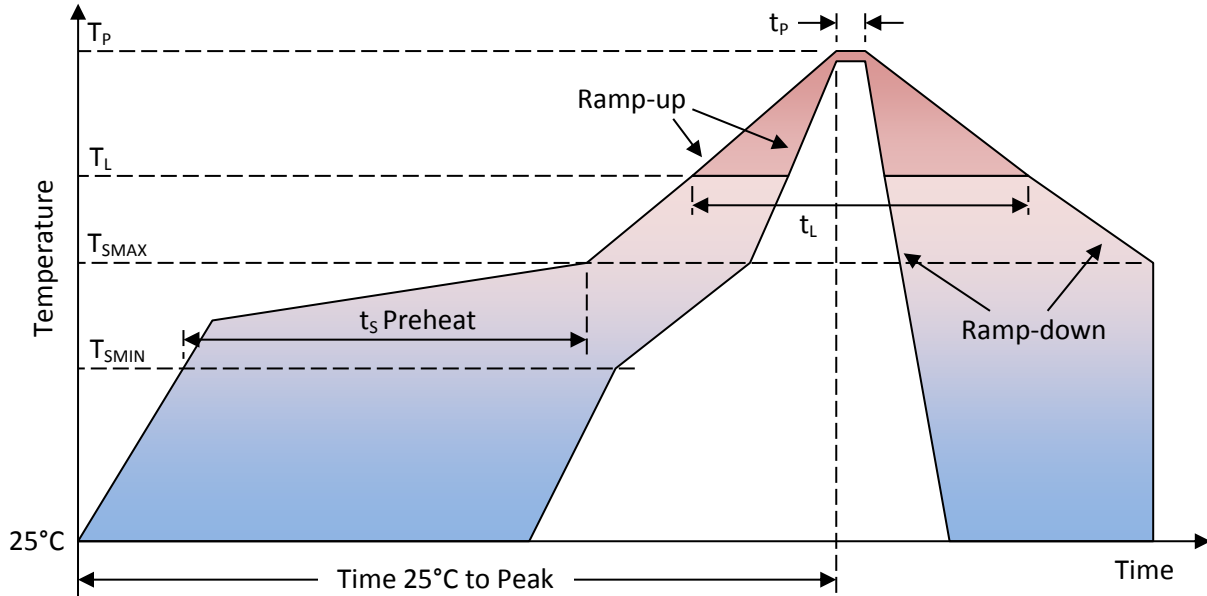

Profile Feature	Pb-Free
Average Ramp-up rate ($T_{S\text{MAX}}$ to T_P)	3°C/second max.
Preheat <ul style="list-style-type: none"> • Temperature Min ($T_{S\text{MIN}}$) • Temperature Max ($T_{S\text{MAX}}$) • Time ($T_{S\text{MIN}}$ to $T_{S\text{MAX}}$) (t_s) 	150°C 200°C 60-180 seconds
Time maintained above: <ul style="list-style-type: none"> • Temperature (T_L) • Time (t_L) 	217°C 60-150 seconds
Peak Temperature (T_P)	260°C
Time within 5°C of actual Peak Temperature (t_p)	20-40 seconds
Ramp-down rate (T_P to $T_{S\text{MAX}}$)	6°C/second max
Time 25°C to Peak Temperature	8 minutes max

Notes: Based on IPC/JDEC J-STD-020 Revision C.

All temperatures refer to topside of the package, measured on the package body surface.



8. ADDITIONAL NOTES

(A) MSL (moisture sensitivity level) Class 1.

(B) Maximum of 3 reflow cycles is recommended.

(C) In order to minimize device damage:

- Do not board wash or clean after the reflow process.
- Do not brush board with or without solvents after the reflow process.
- Do not directly expose to ultrasonic processing, welding, or cleaning.
- Do not insert any object in port hole of device at any time.
- Do not apply over 30 psi of air pressure into the port hole.
- Do not pull a vacuum over port hole of the microphone.
- Do not apply a vacuum when repacking into sealed bags at a rate faster than 0.5 atm/sec.

9. MATERIALS STATEMENT

Meets the requirements of the European RoHS directive 2011/65/EC as amended.

Meets the requirements of the industry standard IEC 61249-2-21:2003 for halogenated substances and Knowles Green Materials Standards Policy section on Halogen-Free.

Product is Beryllium Free according to limit specified on the Knowles Hazardous Material List (HSL for products).

Ozone depleting substances are not used in the product or the processes used to make the product, including compounds listed in Annex A, B, and C of the "Montreal Protocol on Substances That Deplete the Ozone Layer."

10. RELIABILITY SPECIFICATIONS

Test	Description
Thermal Shock	100 cycles air-to-air thermal shock from -40°C to +125°C with 15 minute soaks. (IEC 68-2-4)
High Temperature Storage	1,000 hours at +105°C environment (IEC 68-2-2 Test Ba)
Low Temperature Storage	1,000 hours at -40°C environment (IEC 68-2-2 Test Aa)
High Temperature Bias	1,000 hours at +105°C under bias (IEC 68-2-2 Test Ba)
Low Temperature Bias	1,000 hours at -40°C under bias (IEC 68-2-2 Test Aa)
Temperature / Humidity Bias	1,000 hours at +85°C/85% R.H. under bias. (JESD22-A101A-B)
Vibration	4 cycles of 20 to 2,000 Hz sinusoidal sweep with 20 G peak acceleration lasting 12 minutes in X, Y, and Z directions. (Mil-Std-883E, Method 2007.2 A)
ESD-HBM	3 discharges of ±2 kV direct contact to I/O pins. (MIL 883E, Method 3015.7)
ESD-LID/GND	3 discharges of ±8 kV direct contact to lid while unit is grounded. (IEC 61000-4-2)
ESD-MM	3 discharges of ±200 V direct contact to I/O pins. (ESD STM5.2)
Reflow	5 reflow cycles with peak temperature of +260°C
Mechanical Shock	3 pulses of 10,000 G in the X, Y, and Z direction (IEC 68-2-27, Test Ea)

Notes: After reliability tests are performed, the sensitivity of the microphones shall not deviate more than 3 dB from its initial value.

After 3 reflow cycles, the sensitivity of the microphone shall not deviate more than 1dB from its initial value.

