

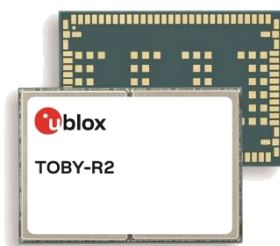

TOBY-R2 series

Multi-mode LTE Cat 1 modules with 2G/3G fallback

Data sheet



Abstract

Technical data sheet describing TOBY-R2 series multi-mode cellular modules. The modules are a cost efficient and performance optimized LTE Cat 1 / 3G / 2G multi-mode solution covering up to six LTE bands, up to four 3G UMTS/HSPA bands, and up to four 2G GSM/EDGE bands in the compact TOBY form factor.

Document information

Title	TOBY-R2 series	
Subtitle	Multi-mode LTE Cat 1 modules with 2G/3G fallback	
Document type	Data sheet	
Document number	UBX-16005785	
Revision and date	R18	30-Mar-2021
Disclosure restriction	C1-Public	

Product status	Corresponding content status	
Functional sample	Draft	For functional testing. Revised and supplementary data will be published later.
In development / Prototype	Objective specification	Target values. Revised and supplementary data will be published later.
Engineering sample	Advance information	Data based on early testing. Revised and supplementary data will be published later.
Initial production	Early production information	Data from product verification. Revised and supplementary data may be published later.
Mass production / End of life	Production information	Document contains the final product specification.

This document applies to the following products:

Product name	Type number	Modem version	Application version	PCN reference	Product status
TOBY-R200	TOBY-R200-02B-00	30.31	A01.01	UBX-17006265	Obsolete
	TOBY-R200-02B-01	30.31	A02.00	UBX-17048314	Obsolete
	TOBY-R200-02B-02	30.31	A02.01	UBX-18018067	Obsolete
	TOBY-R200-02B-03	30.31	A02.02	UBX-18057549	Obsolete
	TOBY-R200-02B-04	30.33	A02.02	UBX-19011731	Mass production
	TOBY-R200-42B-00	30.53	A01.02	UBX-19045985	Mass production
	TOBY-R200-82B-00	30.53	A01.03	UBX-19043497	Mass production
	TOBY-R200-03B-00	30.55	A01.00	UBX-20027523	Mass production
TOBY-R202	TOBY-R202-02B-00	30.31	A01.01	UBX-17006265	Obsolete
	TOBY-R202-02B-01	30.31	A02.00	UBX-17048314	Obsolete
	TOBY-R202-02B-02	30.31	A02.01	UBX-18018067	Obsolete
	TOBY-R202-02B-03	30.31	A02.02	UBX-18057549	Obsolete
	TOBY-R202-02B-04	30.33	A02.02	UBX-19011731	Mass production
	TOBY-R202-02B-34	30.33	A02.04	UBX-19039777	Obsolete

u-blox or third parties may hold intellectual property rights in the products, names, logos and designs included in this document. Copying, reproduction, modification or disclosure to third parties of this document or any part thereof is only permitted with the express written permission of u-blox.

The information contained herein is provided "as is" and u-blox assumes no liability for its use. No warranty, either express or implied, is given, including but not limited to, with respect to the accuracy, correctness, reliability and fitness for a particular purpose of the information. This document may be revised by u-blox at any time without notice. For the most recent documents, visit www.u-blox.com.

Copyright © u-blox AG.

Contents

Document information	2
Contents	3
1 Functional description	5
1.1 Overview.....	5
1.2 Product features	5
1.3 Block diagram	6
1.4 Product description	7
1.5 AT command support	8
1.6 Supported features	8
2 Interfaces	10
2.1 Power management	10
2.1.1 Module supply input (VCC)	10
2.1.2 RTC supply input / output (V_BCKP)	10
2.1.3 Generic digital interfaces supply output (V_INT)	10
2.2 Antenna interfaces.....	10
2.2.1 Antenna RF interfaces.....	10
2.2.2 Antenna detection.....	10
2.3 System functions.....	11
2.3.1 Module power-on	11
2.3.2 Module power-off.....	11
2.3.3 Module reset	12
2.3.4 Module / host configuration selection.....	12
2.4 SIM	12
2.4.1 SIM interface	12
2.4.2 SIM detection	12
2.5 Serial communication	12
2.5.1 UART interface.....	13
2.5.2 USB interface.....	14
2.5.3 DDC (I2C) interface.....	15
2.5.4 SDIO interface	15
2.6 Audio.....	15
2.7 Clock output.....	15
2.8 GPIO	16
3 Pin definition	17
3.1 Pin assignment.....	17
4 Electrical specifications	22
4.1 Absolute maximum rating.....	22
4.1.1 Maximum ESD.....	22
4.2 Operating conditions.....	23
4.2.1 Operating temperature range.....	23
4.2.2 Supply/power pins	23
4.2.3 Current consumption.....	24

4.2.4	LTE RF characteristics	25
4.2.5	3G RF characteristics	26
4.2.6	2G RF characteristics	27
4.2.7	ANT_DET pin.....	27
4.2.8	PWR_ON pin.....	28
4.2.9	RESET_N pin.....	28
4.2.10	SIM pins	28
4.2.11	USB pins	29
4.2.12	DDC (I2C) pins.....	29
4.2.13	Generic Digital Interfaces pins	29
4.3	Parameters for ATEX applications	32
5	Mechanical specifications	33
6	Qualification and approvals.....	34
6.1	Reliability tests	34
6.2	Approvals	34
7	Product handling & soldering.....	35
7.1	Packaging	35
7.1.1	Reels	35
7.1.2	Tapes.....	36
7.2	Moisture sensitivity levels.....	37
7.3	Reflow soldering	37
7.4	ESD precautions.....	37
8	Default settings	38
9	Labeling and ordering information	39
9.1	Product labeling.....	39
9.2	Explanation of codes	39
9.3	Ordering information.....	40
Appendix	41
Related documentation	44
Revision history	45
Contact	46

1 Functional description

1.1 Overview

The TOBY-R2 series comprises LTE Cat 1 / 3G / 2G multi-mode modules in the small TOBY LGA form factor (35.6 x 24.8 mm, 152-pin) that are easy to integrate in compact designs.

TOBY-R2 series modules support up to six LTE bands, up to four 3G UMTS/HSPA bands and up to four 2G GSM/(E)GPRS bands for voice and/or data transmission.

TOBY-R2 series modules are form-factor compatible with u-blox SARA, LISA and LARA cellular module families and are pin-to-pin compatible with u-blox TOBY-L cellular module families: this facilitates easy migration from the u-blox GSM/GPRS, CDMA, UMTS/HSPA, and LTE high data rate modules, maximizes the investments of customers, simplifies logistics, and enables very short time-to-market.

The modules are ideal for applications that are transitioning to LTE from 2G and 3G, due to the long term availability and scalability of LTE networks.

With a range of interface options and an integrated IP stack, the modules are designed to support a wide range of data-centric applications. The unique combination of performance and flexibility make these modules ideally suited for medium speed M2M applications, such as smart energy gateways, remote access video cameras, digital signage, telehealth and telematics.

TOBY-R2 series modules include product versions supporting Voice over LTE (VoLTE) and voice over 3G or 2G (CSFB) for applications that requiring voice, such as security and surveillance systems.

1.2 Product features

Model	Region	Radio access technology			Positioning			Interfaces					Audio		Features								Grade				
		LTE bands ¹	UMTS bands	GSM bands	GNSS via modem	AssistNow Software	CellLocate®	UART	USB 2.0	SDIO *	DDC (I2C)	GPIOs	Analog audio	Digital audio	Network indication	VoLTE	Antenna supervisor	Rx Diversity	Embedded TCP/UDP stack	Embedded HTTP, FTP, SSL	FOTA	Dual stack IPv4 / IPv6	Standard	Professional	Automotive		
TOBY-R200-02B	North America	2,4 5,12	850,900 1900,2100	Quad	■	■	■	1	1	1	1	9	•	•	• ²	•	•	•	•	•	•	•	•	•	•	•	•
TOBY-R200-42B	Global	1,2,4 5,8,12	850,900 1900,2100	Quad	•	•	•	1	1	1	1	9	•	•	•	•	•	•	•	•	•	•	•	•	•	•	•
TOBY-R200-82B	Global	1,2,4 5,8,12	850,900 1900,2100	Quad	•	•	•	1	1	1	1	9	•	•	• ²	•	•	•	•	•	•	•	•	•	•	•	•
TOBY-R200-03B	Global	1,2,4 5,8,12	850,900 1900,2100	Quad	•	•	•	1	1	1	1	9	•	•	• ²	•	•	•	•	•	•	•	•	•	•	•	•
TOBY-R202-02B	North America	2,4 5,12	850,1900		■	■	■	1	1	1	1	9	•	•	• ²	•	•	•	•	•	•	•	•	•	•	•	•

• = Supported by all FW version ■ = Supported by "TOBY-R20x-02B-01" FW version onwards * = HW ready

Table 1: TOBY-R2 series main features summary

¹ LTE band 12 is a superset including band 17: LTE band 12 is supported along with Multi-Frequency Band Indicator feature

² VoLTE available and AT&T certified

1.3 Block diagram

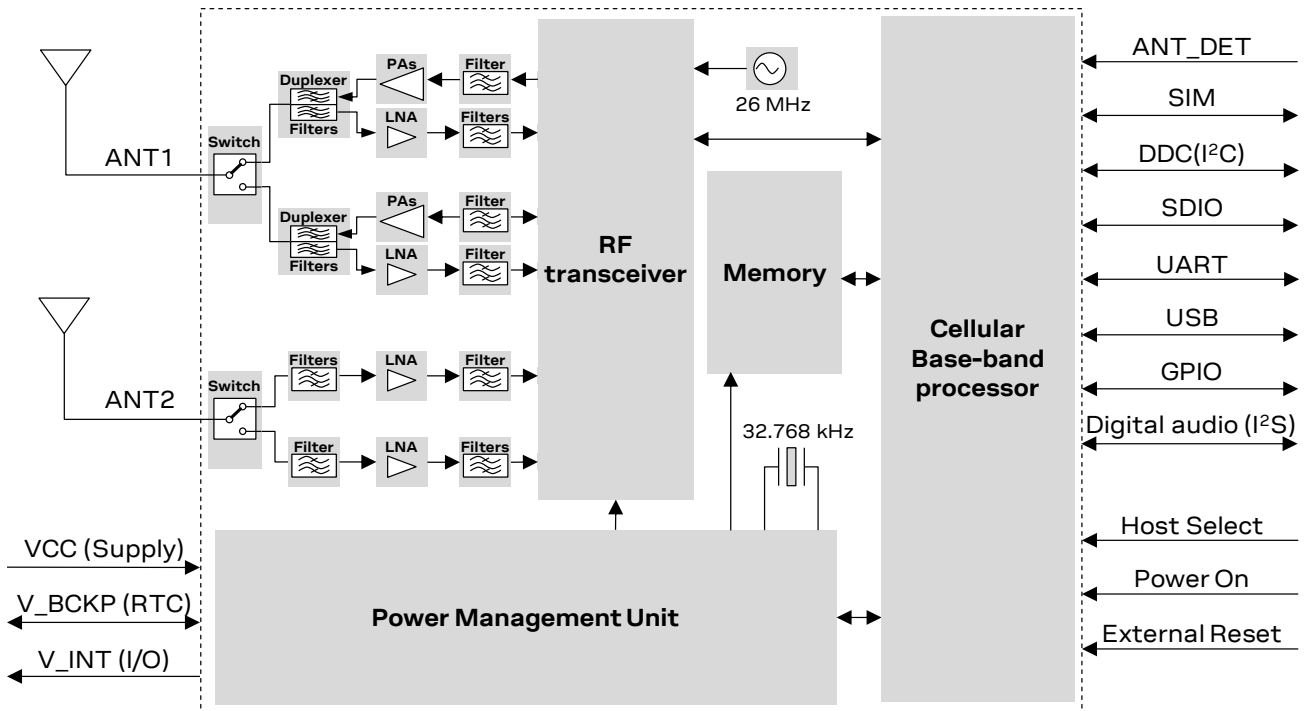

Figure 1: TOBY-R2 series block diagram

The TOBY-R200-02B, TOBY-R200-42B, TOBY-R200-82B, TOBY-R200-03B and TOBY-R202-02B modules, i.e. the "02B", "42B", "82B", and "03B" product versions, do not support the following interfaces, which can be left unconnected and should not be driven by external devices:

- SDIO interface
- HOST_SELECTx pins

1.4 Product description

TOBY-R2 modules provide 4G LTE Cat 1, 3G UMTS / HSPA, 2G GSM/EGPRS multi-mode technology:

- TOBY-R200-02B is designed primarily for operation in North America
- TOBY-R200-03B is designed for worldwide operation, and primarily in North America
- TOBY-R200-42B is designed for worldwide operation, and primarily in North America
- TOBY-R200-82B is designed for worldwide operation, and primarily in North America
- TOBY-R202-02B is designed primarily for operation in North America

4G LTE	3G UMTS/HSDPA/HSUPA	2G GSM/GPRS/EDGE
3GPP Release 9	3GPP Release 9	3GPP Release 9
Long Term Evolution (LTE)	High Speed Packet Access (HSPA)	Enhanced Data rate GSM Evolution (EDGE)
Evolved UTRA (E-UTRA)	UMTS Terrestrial Radio Access (UTRA)	GSM EGPRS Radio Access (GERA)
Frequency Division Duplex (FDD)	Frequency Division Duplex (FDD)	Time Division Multiple Access (TDMA)
DL Rx Diversity	DL Rx Diversity	DL Advanced Rx Performance Phase 1
Band support ³ :	Band support:	Band support:
<ul style="list-style-type: none"> • TOBY-R200: <ul style="list-style-type: none"> • Band 12 (700 MHz)⁴ • Band 8 (900 MHz)⁵ • Band 5 (850 MHz) • Band 4 (1700 MHz) • Band 2 (1900 MHz) • Band 1 (2100 MHz)⁵ • TOBY-R202: <ul style="list-style-type: none"> • Band 12 (700 MHz)⁴ • Band 5 (850 MHz) • Band 4 (1700 MHz) • Band 2 (1900 MHz) 	<ul style="list-style-type: none"> • TOBY-R200: <ul style="list-style-type: none"> • Band 5 (850 MHz) • Band 8 (900 MHz) • Band 2 (1900 MHz) • Band 1 (2100 MHz) • TOBY-R202: <ul style="list-style-type: none"> • Band 5 (850 MHz) • Band 2 (1900 MHz) 	<ul style="list-style-type: none"> • TOBY-R200: <ul style="list-style-type: none"> • GSM 850 MHz • E-GSM 900 MHz • DCS 1800 MHz • PCS 1900 MHz
LTE Power Class	UMTS/HSDPA/HSUPA Power Class	GSM/GPRS (GMSK) Power Class
<ul style="list-style-type: none"> • Class 3 (23 dBm) 	<ul style="list-style-type: none"> • Class 3 (24 dBm) 	<ul style="list-style-type: none"> • Class 4 (33 dBm) for GSM/E-GSM band • Class 1 (30 dBm) for DCS/PCS band EDGE (8-PSK) Power Class <ul style="list-style-type: none"> • Class E2 (27 dBm) for GSM/E-GSM band • Class E2 (26 dBm) for DCS/PCS band
Data rate	Data rate	Data rate ⁶
<ul style="list-style-type: none"> • LTE category 1: up to 10.3 Mb/s DL, 5.2 Mb/s UL 	<ul style="list-style-type: none"> • HSDPA category 8: up to 7.2 Mb/s DL • HSUPA category 6: up to 5.76 Mb/s UL 	<ul style="list-style-type: none"> • GPRS multi-slot class 33⁷, CS1-CS4, up to 107 kb/s DL, up to 85.6 kb/s UL • EDGE multi-slot class 33⁷, MCS1-MCS9, up to 296 kb/s DL, up to 236.8 kb/s UL

Table 2: TOBY-R2 series LTE, 3G and 2G characteristics

TOBY-R2 series modules provide Voice over LTE (VoLTE)⁸ as well as Circuit-Switched-Fall-Back (CSFB) audio capability.

³ TOBY-R2 series modules support all the E-UTRA channel bandwidths for each operating band as per 3GPP TS 36.521-1 [11]:

- Band 12: 1.4 MHz, 3 MHz, 5 MHz, 10 MHz
- Band 5: 1.4 MHz, 3 MHz, 5 MHz, 10 MHz
- Band 4: 1.4 MHz, 3 MHz, 5 MHz, 10 MHz, 15 MHz, 20 MHz
- Band 2: 1.4 MHz, 3 MHz, 5 MHz, 10 MHz, 15 MHz, 20 MHz

⁴ LTE band 12 is a superset including band 17: LTE band 12 is supported along with Multi-Frequency Band Indicator feature

⁵ Not supported by TOBY-R200-02B product version

⁶ GPRS/EDGE multislot class determines the number of timeslots available for upload and download and thus the speed at which data can be transmitted and received, with higher classes typically allowing faster data transfer rates.

⁷ GPRS/EDGE multislot class 33 implies a maximum of 5 slots in DL (reception), 4 slots in UL (transmission) with 6 slots in total.

⁸ AT&T certified

1.5 AT command support

The TOBY-R2 series modules support AT commands according to 3GPP standards TS 27.007 [8], TS 27.005 [9] and the u-blox AT command extension.

 For the complete list of all supported AT commands and their syntax, see the u-blox AT commands manual [1].

RIL (Radio Interface Layer) software for Android and Embedded Windows is available for TOBY-R2 series modules free of charge; see the Android RIL source code [3] and Windows Embedded RIL source code [4] application notes for supported software deliveries and more information.

1.6 Supported features

Table 3 lists some of the main features supported by TOBY-R2 modules. For more details, see TOBY-R2 series system integration manual [2] and u-blox AT commands manual [1].

Feature	Description
Network indication	GPIO configured to indicate the network status: registered home network, registered roaming, voice or data call enabled, no service. The feature can be enabled through the +UGPIOC AT command.
Antenna detection	The ANT_DET pin provides antenna presence detection capability, evaluating the resistance from ANT1 and ANT2 pins to GND by means of an external antenna detection circuit implemented on the application board. The antenna detection feature can be enabled through the +UANTR AT command.
Embedded TCP and UDP stack	Embedded TCP/IP and UDP/IP stack including direct link mode for TCP and UDP sockets. Sockets can be set in Direct Link mode to establish a transparent end to end communication with an already connected TCP or UDP socket via serial interface.
FTP, FTPS	File Transfer Protocol as well as Secure File Transfer Protocol (SSL encryption of FTP control channel) functionalities are supported via AT commands.
HTTP, HTTPS	AT commands support Hyper-Text Transfer Protocol and Secure Hyper-Text Transfer Protocol (SSL encryption) functionalities. HEAD, GET, POST, DELETE and PUT operations are available.
Embedded TLS 1.2	With the support of X.509 certificates, Embedded TLS 1.2 provides server and client authentication, data encryption, data signature and enables TCP/IP applications like HTTPS and FTPS to communicate over a secured and trusted connection. The feature can be configured and enabled by +USECMNG and +USECPRF AT commands.
DNS	Support for DNS functionality.
IPv4/IPv6 dual-stack	Capability to move between IPv4 and dual stack network infrastructures. IPv4 and IPv6 addresses can be used.
BIP	Bearer Independent Protocol for Over-the-Air SIM provisioning. The data transfer to/from the SIM uses either an already active PDP context or a new PDP context established with the APN provided by the SIM card.
Multiple PDP contexts	Up to 8 PDP contexts can be activated, and multi secondary PDP contexts be associated to a primary PDP context
VoLTE and CSFB	Voice over LTE (VoLTE) feature allows voice service over LTE bearer, via embedded IP Multimedia Subsystem (IMS). VoLTE is AT&T certified. Circuit Switched Fall-Back (CSFB) feature allows voice service over circuit switched infrastructure (3G/2G)
Firmware update Over AT commands (FOAT)	Firmware module update Over AT command interfaces. The feature can be enabled and configured through the +UFWUPD AT command.
Firmware update Over The Air (FOTA)	Embedded FOTA client to enable the Firmware module update over the cellular air interface. The feature can be enabled and configured through the +UFWINSTALL AT command.
LTE / 3G Rx Diversity	Improved cellular link quality and reliability on all operating bands, by means of 2 receiving antenna inputs.

Feature	Description
GNSS via modem ⁹	Full access to u-blox positioning chips and modules is available through a dedicated DDC (I2C) interface. This means that from any host processor a single serial port can control the cellular module and the positioning chip or module. For more details, see the GNSS implementation application note [5].
Embedded AssistNow Software ⁹	Embedded AssistNow Online and AssistNow Offline clients are available to provide better GNSS performance and faster Time-to-First-Fix. An AT command can enable / disable the clients.
CellLocate ⁹	Enables the estimation of device position based on the parameters of the mobile network cells visible to the specific device based on the CellLocate [®] database: <ul style="list-style-type: none"> • Normal scan: only the parameters of the visible home network cells are sent CellLocate [®] is available via a set of AT commands for CellLocate [®] service configuration and position request.
Hybrid Positioning ⁹	The current module position is provided by a u-blox positioning chip or module or the estimated position from CellLocate [®] depending on which method provides the best and fastest solution according to the user configuration. Hybrid positioning is available via a set of AT commands that allow the configuration and the position request.
Wi-Fi via modem ¹⁰	Full access to Wi-Fi modules is available through a dedicated SDIO interface. This means that from any host processor a single serial port can control the cellular module and the short range communication module.
DTMF decoder	During a voice call, the Dual-Tone Multi-Frequency detector analyses the RX speech (coming from remote party). The detected DTMF symbols can be output via the related URC. The feature can be enabled and configured through the +UDTMFCFG and +UDTMFD AT commands.
Smart Temperature Supervisor	Constant monitoring of the module board temperature: <ul style="list-style-type: none"> • Warning notification when the temperature approaches an upper or lower predefined threshold • Shutdown notified and forced when the temperature value is outside the specified range (shutdown suspended in case of an emergency call in progress) The Smart Temperature Supervisor feature can be enabled and configured through the +USTS AT command.  The sensor measures board temperature, which can differ from ambient temperature.
Power saving	The power saving configuration is by default disabled, but it can be enabled and configured using the +UPSV AT command. When the power saving is enabled, the module automatically enters the low power idle-mode whenever possible, reducing current consumption. During idle-mode, the module processor core runs with the RTC 32 kHz reference clock, which is generated by the internal 32 kHz oscillator.
Fast Dormancy	The Fast Dormancy feature, defined in 3GPP Rel.8, allows reduction of current consumption and network utilization during periods of data inactivity. It can be activated and configured by +UFDAC and +UDCONF=61 AT commands.
LTE cDRX	Both the Long DRX Cycle and the Short DRX cycle are supported for LTE Connected Discontinuous Reception, allowing reduction of current consumption and LTE network utilization during periods of data inactivity

Table 3: Some of the main features supported by TOBY-R2 series modules

 u-blox is extremely mindful of user privacy. When a position is sent to the CellLocate[®] server u-blox is unable to track the SIM used or the specific device.

⁹ Not supported by TOBY-R200-02B-00 and TOBY-R202-02B-00

¹⁰ Not supported by "02B", "42B", "82B", or "03B" product versions

2 Interfaces

2.1 Power management

2.1.1 Module supply input (VCC)

TOBY-R2 series modules must be supplied through the three **VCC** pins by a DC power supply. Voltage must be stable, because during operation the current drawn from **VCC** can vary by some order of magnitude, especially due to the surging consumption profile of the GSM system (described in the TOBY-R2 series system integration manual [2]). It is important that the system power supply circuit is able to support peak power.

TOBY-R200 modules provide separate supply inputs over the three **VCC** pins:

- **VCC** pins #71 and #72 represent the supply input for the internal RF power amplifier, demanding most of the total current drawn by the module when RF transmission is enabled during a voice/data call
- **VCC** pin #70 represents the supply input for the internal baseband Power Management Unit and the internal transceiver, demanding minor part of the total current drawn by the module when RF transmission is enabled during a voice/data call

2.1.2 RTC supply input / output (V_BCKP)

When **VCC** voltage is within the valid operating range, the internal Power Management Unit (PMU) supplies the Real Time Clock (RTC) and the same supply voltage is available on the **V_BCKP** pin. If the **VCC** voltage is under the minimum operating limit (e.g. during not powered mode), the **V_BCKP** pin can externally supply the RTC.

2.1.3 Generic digital interfaces supply output (V_INT)

TOBY-R2 series modules provide a 1.8 V supply rail output on the **V_INT** pin, which is internally generated when the module is switched on. The same voltage domain is used internally to supply the generic digital interfaces of the modules. The **V_INT** supply output can be used in place of an external discrete regulator.

2.2 Antenna interfaces

2.2.1 Antenna RF interfaces

The modules have two RF pins with a characteristic impedance of 50 Ω . The primary antenna pin (**ANT1**) supports both Tx and Rx, providing the main antenna interface, while the secondary antenna pin (**ANT2**) supports Rx only for the LTE / 3G Rx diversity configuration.

2.2.2 Antenna detection

The **ANT_DET** pin is an Analog to Digital Converter (ADC) input with a current source provided by TOBY-R2 modules to sense the antenna presence (as an optional feature). It evaluates the resistance from **ANT1** and **ANT2** pins to GND by means of an external antenna detection circuit implemented on the application board. For more details, see the TOBY-R2 series system integration manual [2] and the u-blox AT commands manual [1].

2.3 System functions

2.3.1 Module power-on

TOBY-R2 series can be switched on in one of the following ways:

- Rising edge on the **VCC** pins to a valid voltage for module supply, i.e. applying module supply: the modules switch on if the **VCC** supply is applied, starting from a voltage value of less than 2.1 V, with a rise time from 2.3 V to 2.8 V of less than 4 ms, reaching a proper nominal voltage value within **VCC** operating range.

Alternately, in case for example the fast rise time on **VCC** rising edge cannot be guaranteed by the application, TOBY-R2 series modules can be switched on from not-powered mode as following:

- **RESET_N** input pin is held low by the external application during the **VCC** rising edge, so that the modules will switch on when the external application releases the **RESET_N** input pin from the low logic level after the **VCC** supply voltage stabilizes at its proper nominal value within the operating range
- **PWR_ON** input pin is held low by the external application during the **VCC** rising edge, so that the modules will switch on when the external application releases the **PWR_ON** input pin from the low logic level after the **VCC** supply voltage stabilizes at its proper nominal value within the operating range

When the TOBY-R2 series modules are in the power-off mode (i.e. properly switched off as described in section 2.3.2, with valid **VCC** module supply applied), they can be switched on as follows:

- Low pulse on the **PWR_ON** pin, which is normally set high by an internal pull-up, for a valid time period (see section 4.2.8). The **PWR_ON** line should be driven by open drain, open collector or contact switch.
- Rising edge on the **RESET_N** pin, i.e. releasing the pin from the low level, normally set high by an internal pull-up. The **RESET_N** line should be driven by open drain, open collector or contact switch.
- RTC alarm, i.e. pre-programmed scheduled time by AT+CALA command.

2.3.2 Module power-off

TOBY-R2 series can be properly switched off, saving current parameter settings in the module's non-volatile memory and performing a proper network detach, by:

- AT+CPWROFF command (see the u-blox AT commands manual [1]).
- Low pulse on the **PWR_ON** pin, which is normally set high by an internal pull-up, for a valid time period (see section 4.2.8). The **PWR_ON** line should be driven by open drain, open collector or contact switch.

An abrupt under-voltage shutdown occurs on TOBY-R2 series modules when the **VCC** supply is removed. If this occurs, it is not possible to store the current parameter settings in the module's non-volatile memory and to perform the proper network detach.

An abrupt shutdown occurs on TOBY-R2 series modules when a low level is applied on the **RESET_N** pin, which is normally set high by an internal pull-up. If this occurs, it is not possible to store the current parameter settings in the module's non-volatile memory and to perform the proper network detach.

An over-temperature or an under-temperature shutdown occurs on TOBY-R2 modules when the temperature measured within the cellular module reaches the dangerous area, if the optional Smart Temperature Supervisor feature is enabled and configured by the dedicated AT command. For more details, see the TOBY-R2 series system integration manual [2] and the u-blox AT commands manual [1], +USTS AT command.

2.3.3 Module reset

TOBY-R2 series modules can be reset (rebooted) by:

- AT+CFUN command (see the u-blox AT commands manual [1]). This causes an “internal” or “software” reset of the module. The current parameter settings are saved in the module’s non-volatile memory and a proper network detach is performed.

An abrupt “external” or “hardware” reset occurs when a low level is applied to the **RESET_N** pin, which is normally set high by an internal pull-up, for a valid time period (see the section 4.2.9). This causes an “external” or “hardware” reset of the entire module, including the integrated power management unit, except for the RTC internal block: the **V_INT** generic digital interfaces supply is switched off and all the digital pins are tri-stated, but the **V_BCKP** supply and the RTC block are enabled. The current parameter settings are not saved in the module’s non-volatile memory and a proper network detach is not performed. The **RESET_N** line should be driven by open drain, open collector or contact switch.

2.3.4 Module / host configuration selection

-  Selection of module / host configuration over **HOST_SELECT0** and **HOST_SELECT1** pins is not supported.

TOBY-R2 series modules include two pins (**HOST_SELECT0**, **HOST_SELECT1**) for the selection of the module / host application processor configuration.

2.4 SIM

2.4.1 SIM interface

A SIM interface is provided on the **VSIM**, **SIM_IO**, **SIM_CLK**, **SIM_RST** pins: the high-speed SIM/ME interface is implemented as well as the automatic detection of the required SIM supporting voltage.

Both 1.8 V and 3 V SIM types are supported (1.8 V and 3 V ME). Activation and deactivation with automatic voltage switch from 1.8 V to 3 V is implemented, according to ISO-IEC 7816-3 specifications. The SIM driver supports the PPS procedure for baud-rate selection, according to the values proposed by the SIM card/chip.

2.4.2 SIM detection

TOBY-R2 series modules provide the SIM detection function over the **GPIO5** pin to sense the SIM card physical presence (as an optional feature) when the pin of the module is properly connected to the mechanical switch of the SIM card holder (for more details, see the TOBY-R2 series system integration manual [2]).

2.5 Serial communication

TOBY-R2 series provides the following serial communication interfaces:

- UART interface: Universal Asynchronous Receiver/Transmitter serial interface available for the communication with a host processor (AT commands, data communication, FW update by means of FOAT), for FW update by means of the u-blox EasyFlash tool and for diagnostic.
- USB interface: Universal Serial Bus 2.0 compliant interface available for the communication with a host application processor (AT commands, data communication, FW update by means of the FOAT feature), for FW update by means of the u-blox EasyFlash tool and for diagnostic.
- DDC interface: I2C bus compatible interface available for the communication with u-blox GNSS positioning chips/modules and with external I2C devices as an audio codec.
- SDIO interface: Secure Digital Input Output interface available for the communication with compatible u-blox short range radio communication Wi-Fi modules.

2.5.1 UART interface

TOBY-R2 series modules include a 9-wire unbalanced Universal Asynchronous Receiver/Transmitter serial interface (UART) for communication with an application host processor (AT commands, data communication, FW update by means of the FOAT feature), for FW update by means of the u-blox EasyFlash tool and for diagnostic.

UART features are:

- Complete serial port with RS-232 functionality conforming to the ITU-T V.24 recommendation [14], with CMOS compatible signal levels (0 V for low data bit or ON state and 1.8 V for high data bit or OFF state)
- Data lines (**RXD** as output, **TXD** as input), hardware flow control lines (**CTS** as output, **RTS** as input), modem status and control lines (**DTR** as input, **DSR** as output, **DCD** as output, **RI** as output) are provided
- Hardware flow control (default value), software flow control, or none flow control are supported
- Power saving indication available on the hardware flow control output (**CTS** line): the line is driven to the OFF state when the module is not prepared to accept data by the UART interface
- Power saving control over the **RTS** input or the **DTR** input can be enabled via AT+UPSV command (for more details, see the u-blox AT commands manual [1] and TOBY-R2 series system integration manual [2])
- The following baud rates are supported: 9600, 19200, 38400, 57600, 115200 (default baud rate when autobauding is disabled), 230400, 460800, 921600, 3000000, 3250000, 6000000 and 6500000 bit/s
- One-shot autobauding is supported and it is by default enabled: automatic baud rate detection is performed only once, at module start up. After the detection, the module works at the fixed baud rate (the detected one) and the baud rate can only be changed via AT command (see u-blox AT commands manual [1], +IPR).
- The following frame format are supported: 8N2, 8N1 (default format when automatic frame recognition is disabled), 8E1, 8O1, 7E1 and 7O1
- One-shot automatic frame recognition is supported and it is by default enabled in conjunction with automatic baud rate detection (autobauding): the detection is performed only once, at module start up. After the detection, the module works at the detected frame format and it can only be changed via AT command (see u-blox AT commands manual [1], +ICF).

UART serial interface can be conveniently configured through AT commands: see the u-blox AT commands manual [1] (+IPR, +ICF, +IFC, &K, \Q, +UPSV AT commands) and TOBY-R2 series system integration manual [2].

2.5.1.1 Multiplexer protocol

TOBY-R2 series modules include multiplexer functionality as per 3GPP TS 27.010 [10] on the UART physical link.

This is a data link protocol which uses HDLC-like framing and operates between the module (DCE) and the application processor (DTE), allowing a number of simultaneous sessions over the physical link (UART): the user can concurrently use AT interface on one MUX channel and data communication on another MUX channel.

The following virtual channels are available (for details, see mux implementation application note [6]):

- Channel 0: Multiplexer control
- Channel 1 – 5: AT commands / data connection
- Channel 6: GNSS data tunneling

 The GNSS data tunneling channel is not supported by the TOBY-R200-02B-00 and the TOBY-R202-02B-00 type numbers.

2.5.2 USB interface

TOBY-R2 series modules include a USB High-Speed 2.0 compliant interface with maximum 480 Mbit/s data rate according to the Universal Serial Bus specification revision 2.0 [15]. The module itself acts as a USB device and can be connected to any compatible USB host.

The USB interface is available for the communication with a host application processor (AT commands, data communication, FW update by means of the FOAT feature), for FW update by means of the u-blox EasyFlash tool and for diagnostics.

The **USB_D+** / **USB_D-** lines carry the USB data and signaling. The USB interface is automatically enabled by an external valid USB VBUS supply voltage (5.0 V typical) applied on the **VUSB_DET** pin.

The USB interface of TOBY-R2 series modules makes available different USB functions with various capabilities and purposes, such as:

- CDC-ACM for AT commands and data communication
- CDC-ACM for GNSS tunneling
- CDC-ACM for SAP (SIM Access Profile)
- CDC-ACM for Diagnostic log
- CDC-NCM for Ethernet-over-USB

 CDC-ACM for GNSS tunneling is not supported by TOBY-R200-02B-00 and TOBY-R202-02B-00.

 CDC-ACM for SAP, and CDC-NCM for Ethernet-over-USB are not supported by the "02B", "42B", "82B", and "03B" product versions.

The USB interface provides the following set of USB functions:

- 6 CDC-ACM modem COM ports enumerated as follows:
 - USB1: AT and data
 - USB2: AT and data
 - USB3: AT and data
 - USB4: GNSS tunneling
 - USB5: SAP (SIM Access Profile)
 - USB6: Primary Log (diagnostic purpose)

The user can concurrently use the AT command interface on one CDC, and Packet-Switched / Circuit-Switched Data communication on another CDC.

For more details regarding USB capabilities, see the TOBY-R2 series system integration manual [2].

USB drivers are available for the following Windows and Windows Embedded operating system platforms:

- Windows 7
- Windows 8
- Windows 8.1
- Windows 10
- Windows Embedded CE 6.0
- Windows Embedded Compact 7
- Windows Embedded Compact 2013
- Windows 10 IoT

TOBY-R2 series modules are compatible with standard Linux/Android USB kernel drivers.

2.5.3 DDC (I2C) interface

 Communication with u-blox GNSS receivers over DDC (I2C) interface is not supported by the TOBY-R200-02B-00 and TOBY-R202-02B-00 type numbers.

TOBY-R2 series modules include an I2C-bus compatible DDC interface (**SDA**, **SCL**) available to communicate with a u-blox GNSS receiver and with external I2C devices as an audio codec: the TOBY-R2 module acts as an I2C host which can communicate with I2C local devices in accordance with the I2C bus specifications [16].

For more details regarding the DDC (I2C) interface usage and the integration with a u-blox GNSS receiver, see the TOBY-R2 series system integration manual [2], the GNSS implementation application note [5], and the I2C and GNSS AT commands description in the u-blox AT commands manual [1].

2.5.4 SDIO interface

 The SDIO interface is not supported by "02B", "42B", "82B", and "03B" modules product versions.

TOBY-R2 series modules include a 4-bit Secure Digital Input Output interface (**SDIO_D0**, **SDIO_D1**, **SDIO_D2**, **SDIO_D3**, **SDIO_CLK**, **SDIO_CMD**) designed to communicate with external compatible u-blox short range radio communication Wi-Fi modules.

2.6 Audio

TOBY-R2 series modules support Voice over LTE (VoLTE) as well as Circuit-Switched Fall-Back (CSFB) from LTE to 3G or 2G radio bearer for providing audio services.

TOBY-R2 series modules include a 4-wire I2S digital audio interface (**I2S_TXD**, **I2S_RXD**, **I2S_CLK**, **I2S_WA**) that can be configured by AT command in PCM mode (short synchronization signal) or in normal I2S mode (long synchronization signal) to transfer digital audio data to/from an external device as an audio codec.

For more details regarding internal audio processing system capabilities, I2S digital audio interface possible configurations, usage and guideline for the integration with an external digital audio device as an audio codec, see the TOBY-R2 series system integration manual [2] and the audio sections in the u-blox AT commands manual [1].

2.7 Clock output

TOBY-R2 series modules provide a digital clock output function on the **GPIO6** pin, which can be configured to provide a 13 MHz or 26 MHz square wave. This is mainly designed to feed the clock input of an external audio codec, as the clock output can be configured in "Audio dependent" mode (generating the square wave only when the audio path is active), or in "Continuous" mode.

For more details, see the u-blox AT commands manual [1], +UMCLK AT command.

2.8 GPIO

TOBY-R2 series modules include 9 pins (**GPIO1-GPIO5**, **I2S_TXD**, **I2S_RXD**, **I2S_CLK**, **I2S_WA**) that can be configured as general purpose input/output, or to provide custom functions as summarized in [Table 4](#) (for other details, see the TOBY-R2 series system integration manual [\[2\]](#) and GPIO section in u-blox AT commands manual [\[1\]](#)).

Function	Description	Default GPIO	Configurable GPIOs
Network status indication	Network status: registered home network, registered roaming, data transmission, no service	--	GPIO1-GPIO4
GNSS supply enable ¹¹	Enable/disable the supply of u-blox GNSS receiver connected to the cellular module	GPIO2	GPIO1-GPIO4
GNSS data ready ¹¹	Sense when u-blox GNSS receiver connected to the module is ready for sending data by the DDC (I2C)	GPIO3	GPIO3
GNSS RTC sharing ¹²	RTC synchronization signal to the u-blox GNSS receiver connected to the cellular module	--	GPIO4
SIM card detection	External SIM card physical presence detection	GPIO5	GPIO5
SIM card hot insertion/removal	Enable / disable SIM interface upon detection of external SIM card physical insertion / removal	--	GPIO5
I2S digital audio interface	I2S digital audio interface	I2S_RXD, I2S_TXD, I2S_CLK, I2S_WA	I2S_RXD, I2S_TXD, I2S_CLK, I2S_WA
Wi-Fi control ¹²	Control of an external Wi-Fi chip or module	--	--
General purpose input	Input to sense high or low digital level	--	All
General purpose output	Output to set the high or the low digital level	GPIO4	All
Pin disabled	Tri-state with an internal active pull-down enabled	GPIO1	All

Table 4: GPIO custom functions configuration

¹¹ Not supported by TOBY-R200-02B-00 and TOBY-R202-02B-00 type numbers, having GPIO2 and GPIO3 by default disabled

¹² Not supported by "02B", "42B", "82B", or "03B" product versions

3 Pin definition

3.1 Pin assignment

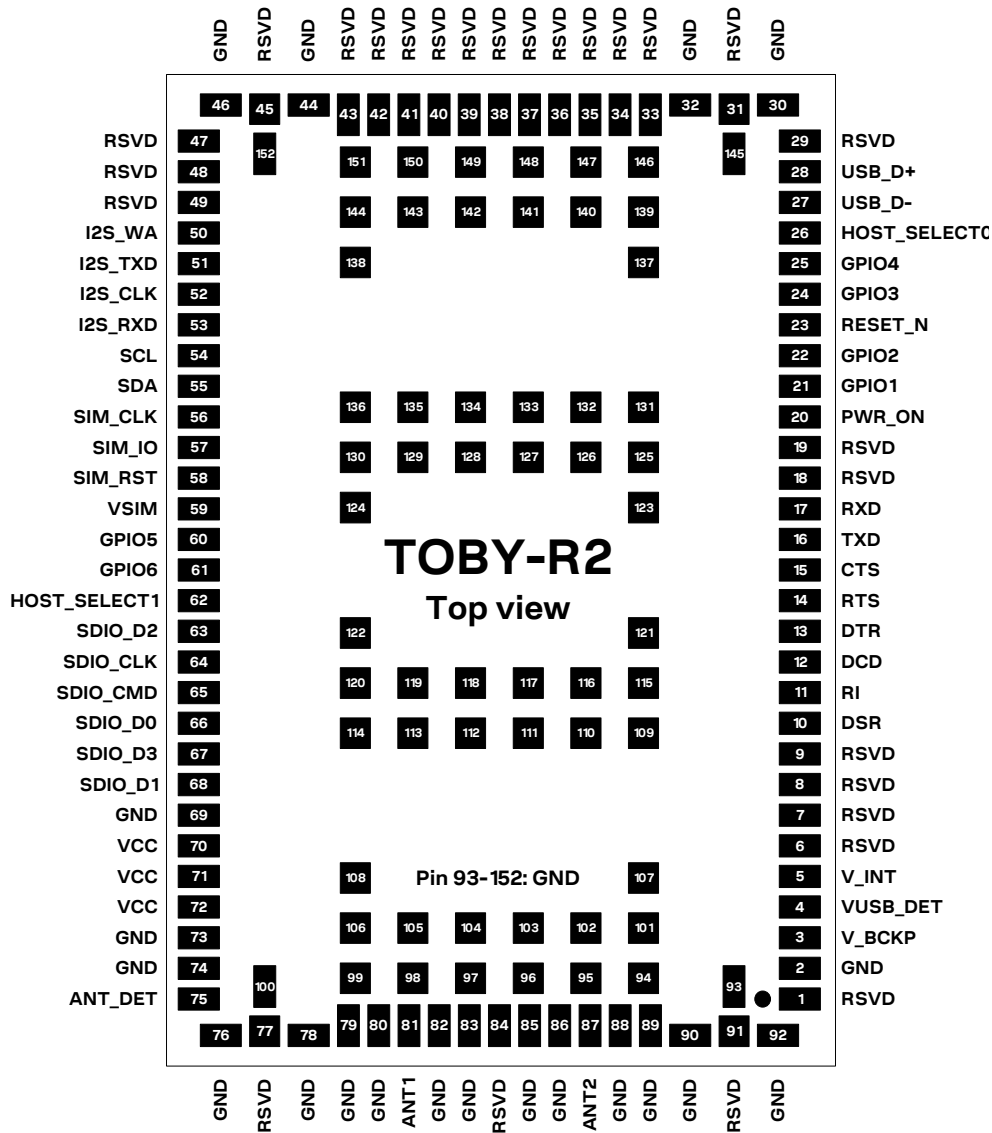

Figure 2: TOBY-R2 series pin assignment (top view)

No	Name	Power domain	I/O	Description	Remarks
1	RSVD	-	N/A	RESERVED pin	Leave unconnected.
2	GND	GND	N/A	Ground	All GND pins must be connected to ground.
3	V_BCKP	-	I/O	RTC supply Input/Output	1.8 V (typical) generated by the module when VCC supply voltage is within valid operating range. See section 4.2.2 for detailed electrical specs.
4	VUSB_DET	VBUS	I	VBUS USB detect input	VBUS (5 V typical) USB supply generated by the host must be connected to this input pin to enable the USB. See section 4.2.11 for detailed electrical specs.
5	V_INT	GDI	O	Generic Digital Interfaces supply output	1.8 V (typical) generated by the module when it is switched-on and with the RESET_N is not forced low. See section 4.2.2 for detailed electrical specs.

No	Name	Power domain	I/O	Description	Remarks
6	RSVD	-	N/A	RESERVED pin	This pin has special function: it must be connected to GND to allow module to work properly.
7	RSVD	-	N/A	RESERVED pin	Leave unconnected.
8	RSVD	-	N/A	RESERVED pin	Leave unconnected.
9	RSVD	-	N/A	RESERVED pin	Leave unconnected.
10	DSR	GDI	O/ I/O	UART data set ready / GPIO	Circuit 107 (DSR) in ITU-T V.24. Output driver class A. PU/PD class a. Value at internal reset: T/PU. See section 4.2.13 for detailed electrical specs.
11	RI	GDI	O/ I/O	UART ring indicator / GPIO	Circuit 125 (RI) in ITU-T V.24. Output driver class A. PU/PD class a. Value at internal reset: T/PU. See section 4.2.13 for detailed electrical specs.
12	DCD	GDI	O/ I/O	UART data carrier detect / GPIO	Circuit 109 (DCD) in ITU-T V.24. Output driver class A. PU/PD class a. Value at internal reset: T/PU. See section 4.2.13 for detailed electrical specs.
13	DTR	GDI	I/ I/O	UART data terminal ready / GPIO	Circuit 108/2 (DTR) in ITU-T V.24. Internal active pull-up to V_INT enabled. PU/PD class a Value at internal reset: T/PU. See section 4.2.13 for detailed electrical specs.
14	RTS	GDI	I	UART ready to send	Circuit 105 (RTS) in ITU-T V.24. Internal active pull-up to V_INT. PU/PD class a. Value at internal reset: T/PU. See section 4.2.13 for detailed electrical specs.
15	CTS	GDI	O	UART clear to send	Circuit 106 (CTS) in ITU-T V.24. Output driver class A. PU/PD class a. Value at internal reset: T/PU. See section 4.2.13 for detailed electrical specs.
16	TXD	GDI	I	UART data input	Circuit 103 (TxD) in ITU-T V.24. Internal active pull-up to V_INT. PU/PD class a. Value at internal reset: T/PU. See section 4.2.13 for detailed electrical specs.
17	RXD	GDI	O	UART data output	Circuit 104 (Rx) in ITU-T V.24. Output driver class A. PU/PD class a. Value at internal reset: T/PU. See section 4.2.13 for detailed electrical specs.
18	RSVD	-	N/A	RESERVED pin	Leave unconnected. Test-Point for diagnostic access is recommended.
19	RSVD	-	N/A	RESERVED pin	Leave unconnected. Test-Point for diagnostic access is recommended.
20	PWR_ON	POS	I	Power-on input	Internal 10 kΩ pull-up resistor to V_BCKP. See section 4.2.8 for detailed electrical specs.
21	GPIO1	GDI	I/O	GPIO	GPIO configurable as described in section 2.8. Output driver class A. PU/PD class b. Value at internal reset: T/PU. See section 4.2.13 for detailed electrical specs.
22	GPIO2	GDI	I/O	GPIO	GPIO configurable as described in section 2.8. Output driver class A. PU/PD class a. Value at internal reset: T/PU. See section 4.2.13 for detailed electrical specs.
23	RESET_N	ERS	I	External reset input	Internal 10 kΩ pull-up resistor to V_BCKP. See section 4.2.9 for detailed electrical specs.

No	Name	Power domain	I/O	Description	Remarks
24	GPIO3	GDI	I/O	GPIO	GPIO configurable as described in section 2.8. Output driver class A. PU/PD class a. Value at internal reset: T/PD. See section 4.2.13 for detailed electrical specs.
25	GPIO4	GDI	I/O	GPIO	GPIO configurable as described in section 2.8. Output driver class A. PU/PD class a. Value at internal reset: T/PD. See section 4.2.13 for detailed electrical specs.
26	HOST_SELECT0	GDI	I/O	Selection of module / host processor configuration	Not supported by '02B', '42B', '82B', '03B' versions. See section 4.2.13 for detailed electrical specs.
27	USB_D-	USB	I/O	USB Data Line D-	90 Ω nominal differential characteristic impedance. Pull-up, pull-down and series resistors as required by the USB revision 2.0 specification [15] are part of the USB pin driver and need not be provided externally. See section 4.2.11 for detailed electrical specs.
28	USB_D+	USB	I/O	USB Data Line D+	90 Ω nominal differential characteristic impedance. Pull-up, pull-down and series resistors as required by the USB revision 2.0 specification [15] are part of the USB pin driver and need not be provided externally. See section 4.2.11 for detailed electrical specs.
29	RSVD	-	N/A	RESERVED pin	Leave unconnected.
30	GND	GND	N/A	Ground	All GND pins must be connected to ground.
31	RSVD	-	N/A	RESERVED pin	Leave unconnected.
32	GND	GND	N/A	Ground	All GND pins must be connected to ground.
33	RSVD	-	N/A	RESERVED pin	Leave unconnected.
34	RSVD	-	N/A	RESERVED pin	Leave unconnected.
35	RSVD	-	N/A	RESERVED pin	Leave unconnected.
36	RSVD	-	N/A	RESERVED pin	Leave unconnected.
37	RSVD	-	N/A	RESERVED pin	Leave unconnected.
38	RSVD	-	N/A	RESERVED pin	Leave unconnected.
39	RSVD	-	N/A	RESERVED pin	Leave unconnected.
40	RSVD	-	N/A	RESERVED pin	Leave unconnected.
41	RSVD	-	N/A	RESERVED pin	Leave unconnected.
42	RSVD	-	N/A	RESERVED pin	Leave unconnected.
43	RSVD	-	N/A	RESERVED pin	Leave unconnected.
44	GND	GND	N/A	Ground	All GND pins must be connected to ground.
45	RSVD	-	N/A	RESERVED pin	Leave unconnected.
46	GND	GND	N/A	Ground	All GND pins must be connected to ground.
47	RSVD	-	N/A	RESERVED pin	Leave unconnected.
48	RSVD	-	N/A	RESERVED pin	Leave unconnected.
49	RSVD	-	N/A	RESERVED pin	Leave unconnected.
50	I2S_WA	GDI	I/O / I/O	I2S word alignment / GPIO	Configurable as I2S word alignment, or GPIO (see 2.8) Output driver class A. PU/PD class a. Value at internal reset: T/PD. See section 4.2.13 for detailed electrical specs.
51	I2S_TXD	GDI	O / I/O	I2S transmit data / GPIO	Configurable as I2S data output, or GPIO (see 2.8) Output driver class A. PU/PD class a. Value at internal reset: T/PD. See section 4.2.13 for detailed electrical specs.
52	I2S_CLK	GDI	I/O / I/O	I2S clock / GPIO	Configurable as I2S clock , or as GPIO (see section 2.8). Output driver class A. PU/PD class a. Value at internal reset: T/PD. See section 4.2.13 for detailed electrical specs.

No	Name	Power domain	I/O	Description	Remarks
53	I2S_RXD	GDI	I/ I/O	I2S receive data / GPIO	Configurable as I2S data input, or GPIO (see 2.8) Output driver class A. PU/PD class a. Value at internal reset: T/PD. See section 4.2.13 for detailed electrical specs
54	SCL	DDC	O	I2C bus clock line	Fixed open drain. See section 4.2.12 for detailed electrical specs.
55	SDA	DDC	I/O	I2C bus data line	Fixed open drain. See section 4.2.12 for detailed electrical specs.
56	SIM_CLK	SIM	O	SIM clock	See section 4.2.10 for detailed electrical specs.
57	SIM_IO	SIM	I/O	SIM data	Internal 4.7 kΩ pull-up resistor to VSIM. See section 4.2.10 for detailed electrical specs.
58	SIM_RST	SIM	O	SIM reset	See section 4.2.10 for detailed electrical specs.
59	VSIM	-	O	SIM supply output	VSIM = 1.8 V typical or 2.9 V typical generated by the module according to the SIM card/chip voltage type. See section 4.2.2 for detailed electrical specs.
60	GPIO5	GDI	I/O	GPIO	Configurable for SIM card detection, or GPIO (see 2.8) Output driver class A. PU/PD class a. Value at internal reset: T/PD. See section 4.2.13 for detailed electrical specs.
61	GPIO6	GDI	O	Clock output	Configurable clock output (see section 2.7) Output driver class A. PU/PD class a. Value at internal reset: T/PD. See section 4.2.13 for detailed electrical specs.
62	HOST_SELECT1	GDI	I/O	Selection of module / host processor configuration	Not supported by '02B', '42B', '82B', '03B' versions. See section 4.2.13 for detailed electrical specs.
63	SDIO_D2	GDI	I/O	SDIO serial data [2]	SDIO not supported by '02B', '42B', '82B', '03B' versions. Output driver class A. PU/PD class a. Value at internal reset: T/PD. See section 4.2.13 for detailed electrical specs.
64	SDIO_CLK	GDI	O	SDIO serial clock	SDIO not supported by '02B', '42B', '82B', '03B' versions. Output driver class A. PU/PD class a. Value at internal reset: T/PD. See section 4.2.13 for detailed electrical specs.
65	SDIO_CMD	GDI	I/O	SDIO command	SDIO not supported by '02B', '42B', '82B', '03B' versions. Output driver class A. PU/PD class a. Value at internal reset: T/PD. See section 4.2.13 for detailed electrical specs.
66	SDIO_D0	GDI	I/O	SDIO serial data [0]	SDIO not supported by '02B', '42B', '82B', '03B' versions. Output driver class A. PU/PD class a. Value at internal reset: T/PD. See section 4.2.13 for detailed electrical specs.
67	SDIO_D3	GDI	I/O	SDIO serial data [3]	SDIO not supported by '02B', '42B', '82B', '03B' versions. Output driver class A. PU/PD class a. Value at internal reset: T/PD. See section 4.2.13 for detailed electrical specs.
68	SDIO_D1	GDI	I/O	SDIO serial data [1]	SDIO not supported by '02B', '42B', '82B', '03B' versions. Output driver class A. PU/PD class a. Value at internal reset: T/PD. See section 4.2.13 for detailed electrical specs.
69	GND	GND	N/A	Ground	All GND pins must be connected to ground.
70	VCC	VCC	I	Module supply input	Supply for BB part on TOBY-R200. Supply for BB part and PA on TOBY-R202. All VCC pins must be connected to external supply. See sections 4.2.2 / 4.2.3 for detailed electrical specs.



No	Name	Power domain	I/O	Description	Remarks
71	VCC	VCC	I	Module supply input	Supply for PA on TOBY-R200. Supply for BB part and PA on TOBY-R202. All VCC pins must be connected to external supply. See sections 4.2.2 / 4.2.3 for detailed electrical specs.
72	VCC	VCC	I	Module supply input	Supply for PA on TOBY-R200. Supply for BB part and PA on TOBY-R202. All VCC pins must be connected to external supply. See sections 4.2.2 / 4.2.3 for detailed electrical specs.
73	GND	GND	N/A	Ground	All GND pins must be connected to ground.
74	GND	GND	N/A	Ground	All GND pins must be connected to ground.
75	ANT_DET	ADC	I	Antenna detection	Antenna presence detection function. See section 4.2.7 for detailed electrical specs.
76	GND	GND	N/A	Ground	All GND pins must be connected to ground.
77	RSVD	-	N/A	RESERVED pin	Leave unconnected.
78	GND	GND	N/A	Ground	All GND pins must be connected to ground.
79	GND	GND	N/A	Ground	All GND pins must be connected to ground.
80	GND	GND	N/A	Ground	All GND pins must be connected to ground.
81	ANT1	ANT	I/O	Primary antenna	50 Ω nominal characteristic impedance. Main Tx / Rx antenna interface. See sections 4.2.3 / 4.2.5 / 4.2.6 for details.
82	GND	GND	N/A	Ground	All GND pins must be connected to ground.
83	GND	GND	N/A	Ground	All GND pins must be connected to ground.
84	RSVD	-	N/A	RESERVED pin	Leave unconnected.
85	GND	GND	N/A	Ground	All GND pins must be connected to ground.
86	GND	GND	N/A	Ground	All GND pins must be connected to ground.
87	ANT2	ANT	I	Secondary antenna	50 Ω nominal characteristic impedance Rx only for Down-Link Rx diversity. See section 4.2.3 for details.
88	GND	GND	N/A	Ground	All GND pins must be connected to ground.
89	GND	GND	N/A	Ground	All GND pins must be connected to ground.
90	GND	GND	N/A	Ground	All GND pins must be connected to ground.
91	RSVD	-	N/A	RESERVED pin	Leave unconnected.
92	GND	GND	N/A	Ground	All GND pins must be connected to ground.
93-152	GND	GND	N/A	Ground	All GND pins must be connected to ground.

Table 5: TOBY-R2 series pin-out

 For more information about the pin-out, see the TOBY-R2 series system integration manual [\[2\]](#).

 See appendix [A](#) for an explanation of abbreviations and terms used.

4 Electrical specifications

-  Stressing the device above one or more of the ratings listed in the Absolute Maximum Rating section may cause permanent damage. These are stress ratings only. Operating the module at these or at any conditions other than those specified in the Operating Conditions sections (section 4.2) of the specification should be avoided. Exposure to Absolute Maximum Rating conditions for extended periods may affect device reliability.
-  Operating condition ranges define those limits within which the functionality of the device is guaranteed.
-  Where application information is given, it is advisory only and does not form part of the specification.

4.1 Absolute maximum rating

-  Limiting values given below are in accordance with the Absolute Maximum Rating System (IEC 134).

Symbol	Description	Condition	Min.	Max.	Unit
VCC	Module supply voltage	Input DC voltage at VCC pin	-0.30	5.00	V
V_BCKP	RTC supply voltage	Input DC voltage at V_BCKP pin	-0.15	2.00	V
VUSB_DET	USB detection pin	Input DC voltage at VUSB_DET pin	-0.15	5.50	V
USB	USB D+/D- pins	Input DC voltage at USB_D+ and USB_D- pins	-1.00	5.50	V
GDI	Generic digital interfaces	Input DC voltage at Generic digital interfaces pins	-0.30	3.60	V
HSIC	HSIC interface	Input DC voltage at HSIC interface pins	-0.30	3.60	V
DDC	DDC interface	Input DC voltage at DDC interface pins	-0.30	3.60	V
SIM	SIM interface	Input DC voltage at SIM interface pins	-0.30	3.60	V
ERS	External reset signal	Input DC voltage at RESET_N pin	-0.30	2.10	V
POS	Power-on input	Input DC voltage at PWR_ON pin	-0.30	2.10	V
Tstg	Storage Temperature		-40	85	°C

Table 6: Absolute maximum ratings

-  The product is not protected against overvoltage or reversed voltages. If necessary, voltage spikes exceeding the power supply voltage specification, given in table above, must be limited to values within the specified boundaries by using appropriate protection devices.

4.1.1 Maximum ESD

Parameter	Min	Typ	Max	Unit	Remarks
ESD sensitivity for all pins except ANT1 / ANT2 pins			1000	V	Human Body Model according to JESD22-A114
ESD sensitivity for ANT1 / ANT2 pins			1000	V	Human Body Model according to JESD22-A114
ESD immunity for ANT1 / ANT2 pins			4000	V	Contact Discharge according to IEC 61000-4-2
			8000	V	Air Discharge according to IEC 61000-4-2

Table 7: Maximum ESD ratings

-  u-blox cellular modules are Electrostatic Sensitive Devices and require special precautions when handling. See section 7.4 for ESD handling instructions.

4.2 Operating conditions

Unless otherwise indicated, all operating condition specifications are at an ambient temperature of +25 °C.

Operation beyond the operating conditions is not recommended and extended exposure beyond them may affect device reliability.

4.2.1 Operating temperature range

Parameter	Min.	Typical	Max.	Unit	Remarks
Normal operating temperature	-20	+25	+65	°C	Normal operating temperature range (fully functional and meet 3GPP specifications)
Extended operating temperature	-40		+85	°C	Extended operating temperature range (RF performance may be affected outside normal operating range, though module is fully functional)

Table 8: Environmental conditions

4.2.2 Supply/power pins

Symbol	Parameter	Min.	Typical	Max.	Unit
VCC	Module supply normal operating input voltage ¹³	3.30	3.80	4.40	V
	Module supply extended operating input voltage ¹⁴	3.00	3.80	4.50	V
	Module supply extended operating input voltage ¹⁵	2.80	3.80	4.50	V
V_BCKP	Real Time Clock supply input voltage	1.00	1.80	1.90	V
I_BCKP	Real Time Clock supply average current consumption, at V_BCKP = 1.8 V		2.00		µA

Table 9: Input characteristics of the Supply/Power pins

Symbol	Parameter	Min.	Typical	Max.	Unit
VSIM	SIM supply output voltage		1.80		V
			2.90		V
V_BCKP	Real Time Clock supply output voltage		1.80		V
I_BCKP	Real Time Clock supply output current capability			3	mA
V_INT	Generic Digital Interfaces supply output voltage		1.80		V
V_INT_RIPPLE	Generic Digital Interfaces supply output voltage ripple with power saving disabled (AT+UPSV=0)			15	mVpp
	Generic Digital Interfaces supply output voltage ripple with power saving enabled (AT+UPSV=1 / 2 / 3)			35	mVpp
I_INT	Generic Digital Interfaces supply output current capability			70	mA

Table 10: Output characteristics of the Supply/Power pins

¹³ RF performance may be affected when the input voltage at **VCC** is outside the herein stated normal operating range limits, though module is still fully functional when the input voltage at **VCC** is inside the extended operating range limits.

¹⁴ Range defined for all the **VCC** pins of TOBY-R202 modules, and the **VCC** pin #70 (supply input for internal baseband Power Management Unit and the internal transceiver) of TOBY-R200 modules. Input voltage at the related **VCC** pins must be above the herein stated extended operating range minimum limit to switch-on the TOBY-R2 series modules. The TOBY-R2 series modules may switch-off when the input voltage at the related **VCC** pins drops below the herein stated extended operating range minimum limit.

¹⁵ Range defined for the **VCC** pins #71 and #72 (supply input for the internal power amplifier) of TOBY-R200 modules.

4.2.3 Current consumption

Mode	Condition	Tx power	Min	Typ ¹⁶	Max ¹⁷	Unit
Idle-Mode (Power Saving enabled by AT+UPSV, module in low power idle-mode, equivalent to airplane mode)	Averaged current value over a 100-ms period, USB not connected			0.9		mA
	Averaged current value over a 100-ms period, USB connected and suspended			1.1		mA
Cyclic Idle/Active-Mode (Power Saving enabled by AT+UPSV, Module registered with network)	Averaged current value over a 10-minute period, USB not connected			1.4		mA
	Averaged current value over a 10-minute period, USB connected and suspended			1.6		mA
Active-Mode (Power Saving disabled by AT+UPSV, Module registered with network)	Averaged current value over a 10-minute period, USB not connected			11.1		mA
	Averaged current value over a 10-minute period, USB connected and not suspended			29.5		mA
2G Connected Mode (Tx / Rx call enabled)	Pulse current during a 1-slot GMSK Tx burst, 850/900 MHz bands	Maximum		1.5	1.9	A
		Minimum		50		mA
	Averaged current value over a 10-s period, 2G GMSK call, 1 Tx + 1 Rx slot, 850/900 MHz	Maximum		220		mA
		Minimum		50		mA
3G Connected Mode (Tx / Rx call enabled)	Averaged current value over a 10-s period	Minimum		120		mA
		0 dBm		130		mA
	12 dBm		175		mA	
	18 dBm		270		mA	
LTE Connected Mode (Tx / Rx call enabled)	Averaged current value over a 10-s period	Maximum		490		mA
		Minimum		185		mA
	0 dBm		200		mA	
	12 dBm		245		mA	
18 dBm		365		mA		
Maximum		540		mA		

Table 11: TOBY-R2 series modules VCC current consumption

Parameter	Min	Typ	Max	Unit
Current consumption through the VCC pin #70 of TOBY-R200 modules (supply input for internal baseband Power Management Unit and the internal transceiver)			300	mA

Table 12: TOBY-R200 modules VCC pin #70 current consumption

¹⁶ Typical values with a matched antenna

¹⁷ Maximum values with a mismatched antenna

4.2.4 LTE RF characteristics

The LTE bands supported by each TOBY-R2 series module are defined in [Table 2](#), while the following [Table 13](#) describes the Transmitting and Receiving frequencies for each LTE band according to 3GPP TS 36.521-1 [11].

Parameter		Min.	Max.	Unit	Remarks
Frequency range Band 12 (700 MHz) ¹⁸	Uplink	699	716	MHz	Module transmits
	Downlink	729	746	MHz	Module receives
Frequency range Band 5 (850 MHz)	Uplink	824	849	MHz	Module transmits
	Downlink	869	894	MHz	Module receives
Frequency range Band 8 (900 MHz)	Uplink	880	915	MHz	Module transmits
	Downlink	925	960	MHz	Module receives
Frequency range Band 4 (1700 MHz)	Uplink	1710	1755	MHz	Module transmits
	Downlink	2110	2155	MHz	Module receives
Frequency range Band 2 (1900 MHz)	Uplink	1850	1910	MHz	Module transmits
	Downlink	1930	1990	MHz	Module receives
Frequency range Band 1 (2100 MHz)	Uplink	1920	1980	MHz	Module transmits
	Downlink	2110	2170	MHz	Module receives

Table 13: LTE operating RF frequency bands

TOBY-R2 series modules include a UE Power Class 3 LTE transmitter (see [Table 2](#)), with output power and characteristics according to 3GPP TS 36.521-1 [11].

TOBY-R2 series modules LTE receiver characteristics are compliant to 3GPP TS 36.521-1 [11], with LTE conducted receiver sensitivity performance described in [Table 14](#).

Parameter	Min.	Typical	Max.	Unit	Remarks
Receiver input sensitivity Band 12 (700 MHz)	-110.5			dBm	Channel bandwidth = 1.4 MHz
	-107.5			dBm	Channel bandwidth = 3 MHz
	-105.0			dBm	Channel bandwidth = 5 MHz
	-102.5			dBm	Channel bandwidth = 10 MHz
Receiver input sensitivity Band 5 (850 MHz)	-110.0			dBm	Channel bandwidth = 1.4 MHz
	-107.5			dBm	Channel bandwidth = 3 MHz
	-105.0			dBm	Channel bandwidth = 5 MHz
	-102.5			dBm	Channel bandwidth = 10 MHz
Receiver input sensitivity Band 8 (900 MHz)	-110.0			dBm	Channel bandwidth = 1.4 MHz
	-107.5			dBm	Channel bandwidth = 3 MHz
	-105.0			dBm	Channel bandwidth = 5 MHz
	-102.5			dBm	Channel bandwidth = 10 MHz
Receiver input sensitivity Band 4 (1700 MHz)	-110.0			dBm	Channel bandwidth = 1.4 MHz
	-107.0			dBm	Channel bandwidth = 3 MHz
	-104.5			dBm	Channel bandwidth = 5 MHz
	-102.0			dBm	Channel bandwidth = 10 MHz
	-100.0			dBm	Channel bandwidth = 15 MHz
	-99.0			dBm	Channel bandwidth = 20 MHz

¹⁸ LTE band 12 is a superset including band 17: LTE band 12 is supported along with Multi-Frequency Band Indicator feature

Parameter	Min.	Typical	Max.	Unit	Remarks
Receiver input sensitivity Band 2 (1900 MHz)		-109.5		dBm	Channel bandwidth = 1.4 MHz
		-107.0		dBm	Channel bandwidth = 3 MHz
		-104.5		dBm	Channel bandwidth = 5 MHz
		-102.0		dBm	Channel bandwidth = 10 MHz
		-100.0		dBm	Channel bandwidth = 15 MHz
		-99.0		dBm	Channel bandwidth = 20 MHz
Receiver input sensitivity Band 1 (2100 MHz)		-104.0		dBm	Channel bandwidth = 5 MHz
		-101.5		dBm	Channel bandwidth = 10 MHz
		-99.5		dBm	Channel bandwidth = 15 MHz
		-98.5		dBm	Channel bandwidth = 20 MHz

Condition: 50 Ω source, Throughput > 95%, dual receiver, QPSK modulation, other settings as per 3GPP TS 36.521-1 [11]

Table 14: LTE receiver sensitivity performance

4.2.5 3G RF characteristics

The 3G bands supported by each TOBY-R2 series module are defined in [Table 2](#), while the following [Table 15](#) describes the Transmitting and Receiving frequencies for each 3G band according to 3GPP TS 34.121-1 [12].

Parameter		Min.	Max.	Unit	Remarks
Frequency range Band 5 (850 MHz)	Uplink	824	849	MHz	Module transmits
	Downlink	869	894	MHz	Module receives
Frequency range Band 8 (900 MHz)	Uplink	880	915	MHz	Module transmits
	Downlink	925	960	MHz	Module receives
Frequency range Band 2 (1900 MHz)	Uplink	1850	1910	MHz	Module transmits
	Downlink	1930	1990	MHz	Module receives
Frequency range Band 1 (2100 MHz)	Uplink	1920	1980	MHz	Module transmits
	Downlink	2110	2170	MHz	Module receives

Table 15: 3G operating RF frequency bands

TOBY-R2 series modules include a UE Power Class 3 3G transmitter (see [Table 2](#)), with output power and characteristics according to 3GPP TS 34.121-1 [12].

TOBY-R2 series modules 3G receiver characteristics are compliant to 3GPP TS 34.121-1 [12], with 3G conducted receiver sensitivity performance described in [Table 16](#).

Parameter	Min.	Typical	Max.	Unit	Remarks
Receiver input sensitivity Band 5 (850 MHz)		-115.0		dBm	Downlink RF level for RMC @ BER < 0.1 %
Receiver input sensitivity Band 8 (900 MHz)		-115.0		dBm	Downlink RF level for RMC @ BER < 0.1 %
Receiver input sensitivity Band 2 (1900 MHz)		-114.0		dBm	Downlink RF level for RMC @ BER < 0.1 %
Receiver input sensitivity Band 1 (2100 MHz)		-114.0		dBm	Downlink RF level for RMC @ BER < 0.1 %

Condition: 50 Ω source, dual receiver, other settings as per 3GPP TS 34.121-1 [12]

Table 16: 3G receiver sensitivity performance

4.2.6 2G RF characteristics

The 2G bands supported by each TOBY-R2 series module are defined in [Table 2](#), while [Table 17](#) describes the Transmitting and Receiving frequencies for each 2G band according to 3GPP TS 51.010-1 [\[13\]](#).

Parameter		Min.	Max.	Unit	Remarks
Frequency range GSM 850	Uplink	824	849	MHz	Module transmits
	Downlink	869	894	MHz	Module receives
Frequency range E-GSM 900	Uplink	880	915	MHz	Module transmits
	Downlink	925	960	MHz	Module receives
Frequency range DCS 1800	Uplink	1710	1785	MHz	Module transmits
	Downlink	1805	1880	MHz	Module receives
Frequency range PCS 1900	Uplink	1850	1910	MHz	Module transmits
	Downlink	1930	1990	MHz	Module receives

Table 17: 2G operating RF frequency bands

TOBY-R2 series modules include a GMSK Power Class 4 transmitter for GSM 850 and E-GSM 900 bands, a GMSK Power Class 1 transmitter for DCS 1800 and PCS 1900 bands, a 8-PSK Power Class E2 transmitter for all 2G bands (see [Table 2](#)), with output power and characteristics according to 3GPP TS 51.010-1 [\[13\]](#).

TOBY-R2 series modules 2G receiver characteristics are compliant to 3GPP TS 51.010-1 [\[13\]](#), with conducted receiver sensitivity performance described in [Table 18](#).

Parameter	Min.	Typical	Max.	Unit	Remarks
Receiver input sensitivity GSM 850		-110.0		dBm	Downlink RF level @ BER Class II < 2.4 %
Receiver input sensitivity E-GSM 900		-110.0		dBm	Downlink RF level @ BER Class II < 2.4 %
Receiver input sensitivity DCS 1800		-109.0		dBm	Downlink RF level @ BER Class II < 2.4 %
Receiver input sensitivity PCS 1900		-109.0		dBm	Downlink RF level @ BER Class II < 2.4 %

Condition: 50 Ω source, other settings as per 3GPP TS 51.010-1 [\[13\]](#)

Table 18: 2G receiver sensitivity performance

4.2.7 ANT_DET pin

Pin name	Parameter	Min.	Typical	Max.	Unit	Remarks
ANT_DET	Output DC current pulse value		9		μ A	Generated by means of the +UANTR AT command
	Output DC current pulse time length		330		μ s	Generated by means of the +UANTR AT command

Table 19: ANT_DET pin characteristics

4.2.8 PWR_ON pin

Pin name	Parameter	Min.	Typical	Max.	Unit	Remarks
PWR_ON	Internal supply for Power-On Input Signal		1.80		V	RTC supply (V_BCKP)
	Low-level input	-0.30		0.54	V	
	High-level input	1.26		2.10	V	
	Pull-up resistance		10		k Ω	Internal active pull-up to V_BCKP
	Low-level input current		-180		μ A	
	Low pulse time	50			μ s	Low pulse time to switch-on the module
	Low pulse time	1			s	Low pulse time to switch-off the module

Table 20: PWR_ON pin characteristics

4.2.9 RESET_N pin

Pin name	Parameter	Min.	Typical	Max.	Unit	Remarks
RESET_N	Internal supply for External Reset Input Signal		1.80		V	RTC supply (V_BCKP)
	Low-level input	-0.30		0.54	V	
	High-level input	1.26		2.10	V	
	Pull-up resistance		10		k Ω	Internal active pull-up to V_BCKP
	Low-level input current		-180		μ A	
	Low pulse time	50			ms	Low pulse time to reset the module

Table 21: RESET_N pin characteristics

4.2.10 SIM pins

The SIM pins are a dedicated interface to the external SIM card/chip. The electrical characteristics fulfill regulatory specification requirements. The values in [Table 22](#) are for information only.

Parameter	Min.	Typical	Max.	Unit	Remarks
Low-level input	0.00		0.35	V	VSIM = 1.80 V
	0.00		0.57	V	VSIM = 2.90 V
High-level input	1.29		3.30	V	VSIM = 1.80 V
	2.07		3.30	V	VSIM = 2.90 V
Low-level output		0.00	0.35	V	VSIM = 1.80 V, Max value at I _{OL} = +1.0 mA
		0.00	0.35	V	VSIM = 2.90 V, Max value at I _{OL} = +1.0 mA
High-level output	1.26	1.80		V	VSIM = 1.80 V, Min value at I _{OH} = -1.0 mA
	2.03	2.90		V	VSIM = 2.90 V, Min value at I _{OH} = -1.0 mA
Input / Output leakage current			0.7	μ A	0.2V < V _{IN} < 3.3V
Clock frequency on SIM_CLK		3.25		MHz	
Internal pull-up resistor on SIM_IO		4.7		k Ω	Internal pull-up to VSIM supply

Table 22: SIM pins characteristics

4.2.11 USB pins

USB data lines (**USB_D+** / **USB_D-**) are compliant to the USB 2.0 high-speed specification. See the Universal Serial Bus specification revision 2.0 [15] for detailed electrical characteristics. The values in [Table 23](#) related to USB 2.0 high-speed physical layer specifications are for information only.

Parameter	Min.	Typ.	Max.	Unit	Remarks
VUSB_DET pin, High-level input	1.50	5.00	5.25	V	
VUSB_DET pin, Low-level input	-0.15	0.00	0.40	V	
VUSB_DET pin, input current sink		25		μA	
High-speed squelch detection threshold (input differential signal amplitude)	100		150	mV	
High speed disconnect detection threshold (input differential signal amplitude)	525		625	mV	
High-speed data signaling input common mode voltage range	-50		500	mV	
High-speed idle output level	-10		10	mV	
High-speed data signaling output high level	360		440	mV	
High-speed data signaling output low level	-10		10	mV	
Chirp J level (output differential voltage)	700		1100	mV	
Chirp K level (output differential voltage)	-900		-500	mV	

Table 23: USB pins characteristics

4.2.12 DDC (I2C) pins

DDC (I2C) lines (**SCL** and **SDA**) are compliant to the I2C-bus standard mode specification. See the I2C-bus specification [16] for detailed electrical characteristics. The values in [Table 24](#) related to the I2C-bus standard mode specifications are for information only.

Parameter	Min	Typical	Max	Unit	Remarks
Internal supply for GDI domain		1.80		V	Digital I/O Interfaces supply (V_INT)
Low-level input	-0.20		0.36	V	
High-level input	1.26		2.00	V	
Low-level output		0.00	0.35	V	Max value at I _{OL} = +1.0 mA
Clock frequency on SCL		100		kHz	

Table 24: DDC (I2C) pins characteristics

4.2.13 Generic Digital Interfaces pins

Parameter	Min	Typical	Max	Unit	Remarks
Internal supply for GDI domain		1.80		V	Digital I/O Interfaces supply (V_INT)
Low-level input	-0.20		0.36	V	
High-level input	1.26		2.00	V	
Low-level output		0.00	0.35	V	Max value at I _{OL} = +6.0 mA for driver class A
High-level output	1.45	1.80		V	Min value at I _{OH} = -6.0 mA for driver class A
Internal pull-up input current			-240	μA	PU class a
			-110	μA	PU class b
Internal pull-down input current			240	μA	PD class a
			100	μA	PD class b
Input/output leakage current			0.7	μA	0.2V < V _{IN} < 2.0V

Table 25: GDI pin characteristics

4.2.13.1 AC characteristics of clock output pin

Parameter	Description	Min	Typical	Max	Unit	Remarks
1/T1	GPIO6 clock output frequency		13		MHz	AT+UMCLK=2
			26		MHz	AT+UMCLK=3

Table 26: AC characteristics of the GPIO6 clock output pin

4.2.13.2 AC characteristics of I2S pins

Parameter	Description	Min	Typical	Max	Unit	Remarks
1/T1	I2S_WA frequency		8.000		kHz	<I2S_sample_rate>=0
			11.025		kHz	<I2S_sample_rate>=1
			12.000		kHz	<I2S_sample_rate>=2
			16.000		kHz	<I2S_sample_rate>=3
			22.050		kHz	<I2S_sample_rate>=4
			24.000		kHz	<I2S_sample_rate>=5
			32.000		kHz	<I2S_sample_rate>=6
			44.100		kHz	<I2S_sample_rate>=7
	48.000		kHz	<I2S_sample_rate>=8		
1/T2	I2S_CLK frequency		32		1/T1	<I2S_mode> = 2,...,13
T3	I2S_TXD invalid before I2S_CLK edge			24	ns	<I2S_mode> = 2,...,13
T4	I2S_TXD valid after I2S_CLK edge			32	ns	<I2S_mode> = 2,...,13
T5	I2S_RXD setup time before I2S_CLK edge	60			ns	<I2S_mode> = 2,...,13
T6	I2S_RXD hold time after I2S_CLK edge	10			ns	<I2S_mode> = 2,...,13

Table 27: AC characteristics of digital audio interface (I2S) pins in Normal I2S mode (long synchronization signal), host role

Parameter	Description	Min	Typical	Max	Unit	Remarks
1/T1	I2S_WA frequency			8.000	kHz	<I2S_sample_rate>=0
				11.025	kHz	<I2S_sample_rate>=1
				12.000	kHz	<I2S_sample_rate>=2
				16.000	kHz	<I2S_sample_rate>=3
				22.050	kHz	<I2S_sample_rate>=4
				24.000	kHz	<I2S_sample_rate>=5
				32.000	kHz	<I2S_sample_rate>=6
				44.100	kHz	<I2S_sample_rate>=7
			48.000	kHz	<I2S_sample_rate>=8	
1/T2	I2S_CLK frequency			32	1/T1	<I2S_mode> = 2,...,13
T3	I2S_TXD invalid before I2S_CLK edge			12	ns	<I2S_mode> = 2,...,13
T4	I2S_TXD valid after I2S_CLK edge			79	ns	<I2S_mode> = 2,...,13
T5	I2S_RXD setup time before I2S_CLK edge	22			ns	<I2S_mode> = 2,...,13
T6	I2S_RXD hold time after I2S_CLK edge	24			ns	<I2S_mode> = 2,...,13

Table 28: AC characteristics of digital audio interface (I2S) pins in Normal I2S mode (long synchronization signal), device role

Parameter	Description	Min	Typical	Max	Unit	Remarks
1/T1	I2S_WA frequency		8.000		kHz	<I2S_sample_rate>=0
			11.025		kHz	<I2S_sample_rate>=1
			12.000		kHz	<I2S_sample_rate>=2
			16.000		kHz	<I2S_sample_rate>=3
			22.050		kHz	<I2S_sample_rate>=4
			24.000		kHz	<I2S_sample_rate>=5
			32.000		kHz	<I2S_sample_rate>=6
			44.100		kHz	<I2S_sample_rate>=7
1/T2	I2S_CLK frequency		18		1/T1	<I2S_mode> = 0
			17		1/T1	<I2S_mode> = 1
T3	I2S_WA high begin after I2S_CLK high begin	-24		32	ns	<I2S_mode> = 0, 1
T4	I2S_WA high end after I2S_CLK low end	-24		32	ns	<I2S_mode> = 0, 1
T5	I2S_TXD invalid before I2S_CLK low end			24	ns	<I2S_mode> = 0, 1
T6	I2S_TXD valid after I2S_CLK high begin			22	ns	<I2S_mode> = 0, 1
T7	I2S_RXD setup time before I2S_CLK high end	60			ns	<I2S_mode> = 0, 1
T8	I2S_RXD hold time after I2S_CLK low begin	12			ns	<I2S_mode> = 0, 1

Table 29: AC characteristics of digital audio interface (I2S) pins in PCM mode (short synchronization signal), host role

Parameter	Description	Min	Typical	Max	Unit	Remarks
1/T1	I2S_WA frequency			8.000	kHz	<I2S_sample_rate>=0
				11.025	kHz	<I2S_sample_rate>=1
				12.000	kHz	<I2S_sample_rate>=2
				16.000	kHz	<I2S_sample_rate>=3
				22.050	kHz	<I2S_sample_rate>=4
				24.000	kHz	<I2S_sample_rate>=5
				32.000	kHz	<I2S_sample_rate>=6
				44.100	kHz	<I2S_sample_rate>=7
1/T2	I2S_CLK frequency			18	1/T1	<I2S_mode> = 0
				17	1/T1	<I2S_mode> = 1
T3	I2S_WA high begin before I2S_CLK low begin	36			ns	<I2S_mode> = 0, 1
T4	I2S_WA low begin before I2S_CLK low begin	36			ns	<I2S_mode> = 0, 1
T5	I2S_TXD invalid before I2S_CLK rising edge			12	ns	<I2S_mode> = 0, 1
T6	I2S_TXD valid after I2S_CLK rising edge			79	ns	<I2S_mode> = 0, 1
T7	I2S_RXD setup time before I2S_CLK falling edge	22			ns	<I2S_mode> = 0, 1
T8	I2S_RXD hold time after I2S_CLK falling edge	24			ns	<I2S_mode> = 0, 1

Table 30: AC characteristics of digital audio interface (I2S) pins in PCM mode (short synchronization signal), device role

4.3 Parameters for ATEX applications

This section provides useful parameters and information to integrate TOBY-R2 series modules in applications intended for use in areas with potentially explosive atmospheres (ATEX), describing:

- Total internal capacitance and inductance of TOBY-R2 series modules (see [Table 31](#))
- Maximum RF output power at the antenna pin of TOBY-R2 series modules (see [Table 32](#))

 Any specific applicable requirement for the implementation of the apparatus integrating TOBY-R2 series modules, intended for use in potentially explosive atmospheres, must be fulfilled according to the exact applicable standards: check the detailed requisites on the pertinent normative for the application, as for example the IEC 60079-0 [\[17\]](#), the IEC 60079-11 [\[18\]](#), and the IEC 60079-26 [\[19\]](#) standards.

 The certification of the application device that integrates a TOBY-R2 series module and the compliance of the application device with all the applicable certification schemes, directives and standards required for use in potentially explosive atmospheres are the sole responsibility of the application device manufacturer.

[Table 31](#) describes the maximum total internal capacitance and the maximum total internal inductance, considering internal parts tolerance, provided by TOBY-R2 series modules.

Module	Parameter	Description	Value	Unit
TOBY-R200	Ci	Maximum total internal capacitance	218	μF
	Li	Maximum total internal inductance	26.3	μH
TOBY-R202	Ci	Maximum total internal capacitance	214	μF
	Li	Maximum total internal inductance	26.2	μH

Table 31: TOBY-R2 series maximum total internal capacitance and maximum total internal inductance

[Table 32](#) describes the maximum RF output power transmitted by TOBY-R2 series modules from the primary antenna (**ANT1**) pin as Power Class 4 Mobile Station for GSM 850 / E-GSM 900 bands and/or as Power Class 3 User Equipment for LTE / UMTS bands.

Module	Parameter	Description	Value	Unit
TOBY-R200	ANT1 Pout	Maximum RF output power from ANT1 pin	35.0	dBm
TOBY-R202	ANT1 Pout	Maximum RF output power from ANT1 pin	25.0	dBm

Table 32: TOBY-R2 series antenna pin (ANT1) maximum RF output power

5 Mechanical specifications

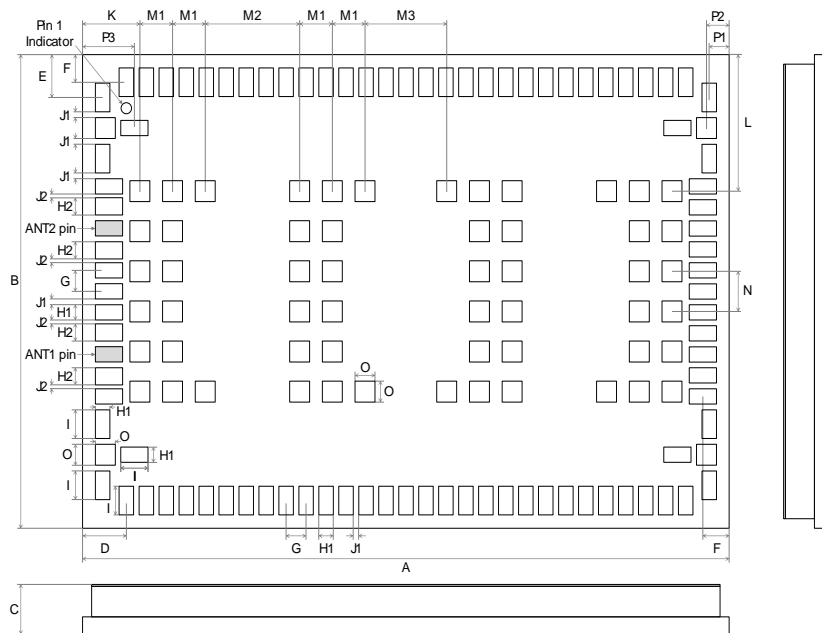

Figure 3: TOBY-R2 series dimensions (bottom and side views)

Parameter	Description	Typical		Tolerance	
A	Module height [mm]	35.6	(1401.6 mil)	+0.20/-0.20	(+7.9/-7.9 mil)
B	Module width [mm]	24.8	(976.4 mil)	+0.20/-0.20	(+7.9/-7.9 mil)
C	Module thickness [mm]	2.6	(102.4 mil)	+0.27/-0.17	(+10.6/-6.7 mil)
D	Horizontal edge to lateral pin pitch [mm]	2.4	(94.5 mil)	+0.20/-0.20	(+7.9/-7.9 mil)
E	Vertical edge to lateral pin pitch [mm]	2.25	(88.6 mil)	+0.20/-0.20	(+7.9/-7.9 mil)
F	Edge to lateral pin pitch [mm]	1.45	(57.1 mil)	+0.20/-0.20	(+7.9/-7.9 mil)
G	Lateral pin to pin pitch [mm]	1.1	(43.3 mil)	+0.05/-0.05	(+2.0/-2.0 mil)
H1	Lateral pin height [mm]	0.8	(31.5 mil)	+0.05/-0.05	(+2.0/-2.0 mil)
H2	Lateral pin close to ANT1 and ANT2 height [mm]	0.9	(35.4 mil)	+0.05/-0.05	(+2.0/-2.0 mil)
I	Lateral pin width [mm]	1.5	(59.1 mil)	+0.05/-0.05	(+2.0/-2.0 mil)
J1	Lateral pin to pin distance [mm]	0.3	(11.8 mil)	+0.05/-0.05	(+2.0/-2.0 mil)
J2	Lateral pin to pin close to ANT distance [mm]	0.2	(7.9 mil)	+0.05/-0.05	(+2.0/-2.0 mil)
K	Horizontal edge to central pin pitch [mm]	3.15	(124.0 mil)	+0.20/-0.20	(+7.9/-7.9 mil)
L	Vertical edge to central pin pitch [mm]	7.15	(281.5 mil)	+0.20/-0.20	(+7.9/-7.9 mil)
M1	Central pin to pin horizontal pitch [mm]	1.8	(70.9 mil)	+0.05/-0.05	(+2.0/-2.0 mil)
M2	Central pin to pin horizontal pitch [mm]	5.2	(204.7 mil)	+0.05/-0.05	(+2.0/-2.0 mil)
M3	Central pin to pin horizontal pitch [mm]	4.5	(177.2 mil)	+0.05/-0.05	(+2.0/-2.0 mil)
N	Central pin to pin vertical pitch [mm]	2.1	(82.7 mil)	+0.05/-0.05	(+2.0/-2.0 mil)
O	Central pin height and width [mm]	1.1	(43.3 mil)	+0.05/-0.05	(+2.0/-2.0 mil)
P1	Horizontal edge to corner pin pitch [mm]	1.1	(43.3 mil)	+0.20/-0.20	(+7.9/-7.9 mil)
P2	Horizontal edge to corner pin pitch [mm]	1.25	(49.2 mil)	+0.20/-0.20	(+7.9/-7.9 mil)
P3	Horizontal edge to corner pin pitch [mm]	2.85	(112.2 mil)	+0.20/-0.20	(+7.9/-7.9 mil)
Weight	Module weight [g]	4.8			

Table 33: TOBY-R2 series dimensions

- Module height tolerance ± 0.20 mm may be exceeded close to the corners of the PCB due to cutting process: in worst case the Height could be $+0.40$ mm longer than the typical value.
- For information regarding footprint and paste mask recommended for the application board integrating the cellular module, see TOBY-R2 series system integration manual [2].

6 Qualification and approvals

6.1 Reliability tests

Tests for product family qualifications according to ISO 16750 "Road vehicles - Environmental conditions and testing for electrical and electronic equipment", and appropriate standards.

6.2 Approvals

TOBY-R2 series modules comply with the Directive 2011/65/EU of the European Parliament and the Council on the Restriction of Use of certain Hazardous Substances in Electrical and Electronic Equipment (EU RoHS 2) and its amendment Directive (EU) 2015/863 (EU RoHS 3).

TOBY-R2 series modules are RoHS 3 compliant.

No natural rubbers, hygroscopic materials, or materials containing asbestos are employed.

[Table 34](#) summarizes the main approvals for TOBY-R2 series modules.

Certification scheme	TOBY-R200-02B	TOBY-R200-42B	TOBY-R200-82B	TOBY-R200-03B	TOBY-R202-02B
CE (Europe)	■	■	■	■	
Model name	TOBY-R200	TOBY-R200	TOBY-R200	TOBY-R200	
FCC (United States)	■	■	■	■	■
Identification number	XPY1EHM44NN	XPY1EHM44NN	XPY1EHM44NN	XPY1EHM44NN	XPY1EHQ24NN
ISED (Canada)	■	■	■	■	■
Certification number	8595A-1EHM44NN	8595A-1EHM44NN	8595A-1EHM44NN	8595A-1EHM44NN	8595A-1EHQ24NN
ANATEL (Brazil)				■	
Certification number				04141-21-05903	
PTCRB	■	■	■	■	■
Model name	TOBY-R200	TOBY-R200-42	TOBY-R200-82	TOBY-R200-03	TOBY-R202
AT&T (network operator)	■		■	■	■
Model name	TOBY-R200		TOBY-R200-82	TOBY-R200-03	TOBY-R202
T-Mobile US (network operator)	□		□	□	□
Model name	TOBY-R200		TOBY-R200-82	TOBY-R200-03	TOBY-R202
U.S. Cellular (network operator)			□	□	□
Model name			TOBY-R200-82	TOBY-R200-03	TOBY-R202
Telus (network operator)			□	□	
Model name			TOBY-R200-82	TOBY-R200-03	
Note:	■ = certified as voice and data		□ = certified as data only		

Table 34: TOBY-R2 series main certification approvals summary

The above listed certifications might not be available for all the different product type numbers. Please contact the u-blox office or sales representative nearest you for the complete list of certification approvals available for the selected product ordering number.

7 Product handling & soldering

7.1 Packaging

TOBY-R2 series modules are delivered as hermetically sealed, reeled tapes to enable efficient production, production lot set-up and tear-down. For more information about packaging, see the u-blox package information user guide [7].

7.1.1 Reels

TOBY-R2 series modules are deliverable in quantities of 150 pieces on a reel. The modules are delivered using the reel type B3 described in the Figure 4 and in the u-blox package information user guide [7].

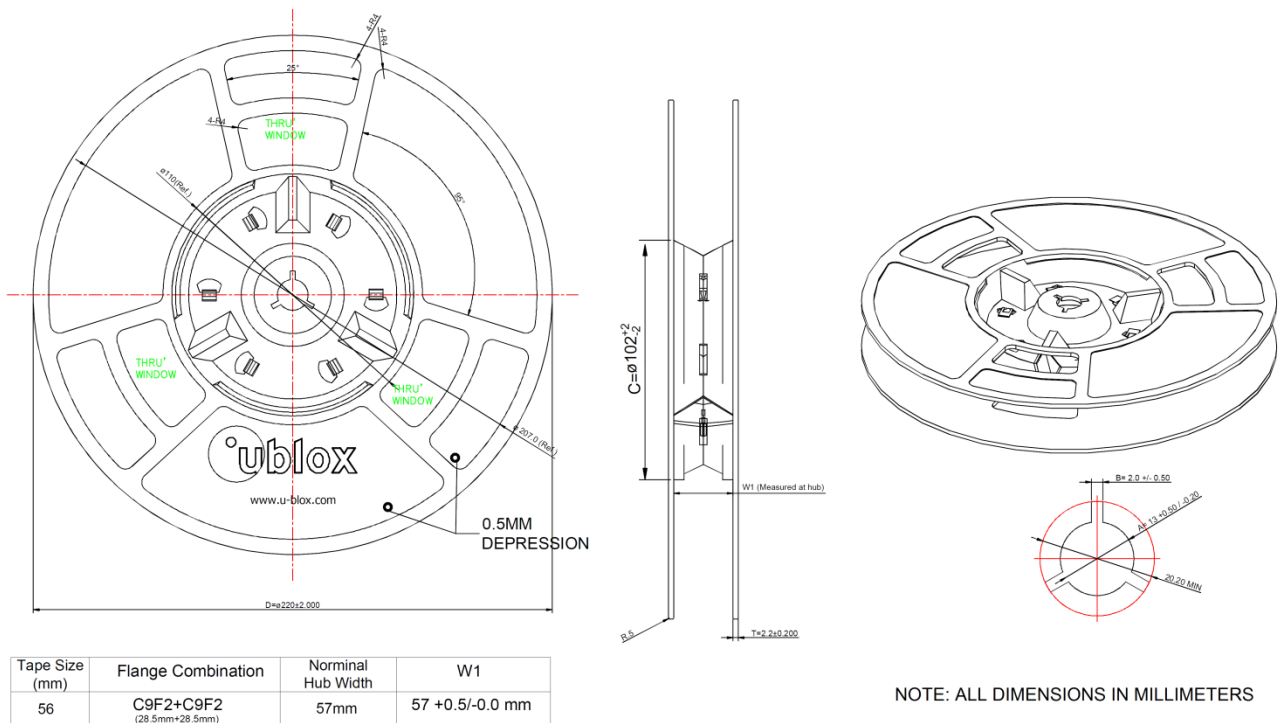

Figure 4: TOBY-R2 series modules reel

Parameter	Specification
Reel type	B3
Delivery quantity	150

Table 35: Reel information for TOBY-R2 series modules

Quantities of less than 150 pieces are also available. Contact u-blox for more information.

7.1.2 Tapes

Figure 5 shows the position and the orientation of TOBY-R2 modules as they are delivered on the tape, while the Figure 6 specifies the tape dimensions.

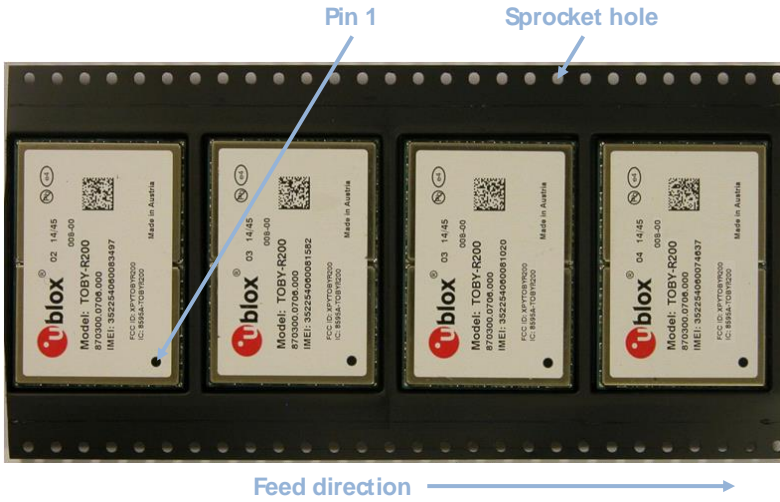

Figure 5: Orientation for TOBY-R2 modules on tape

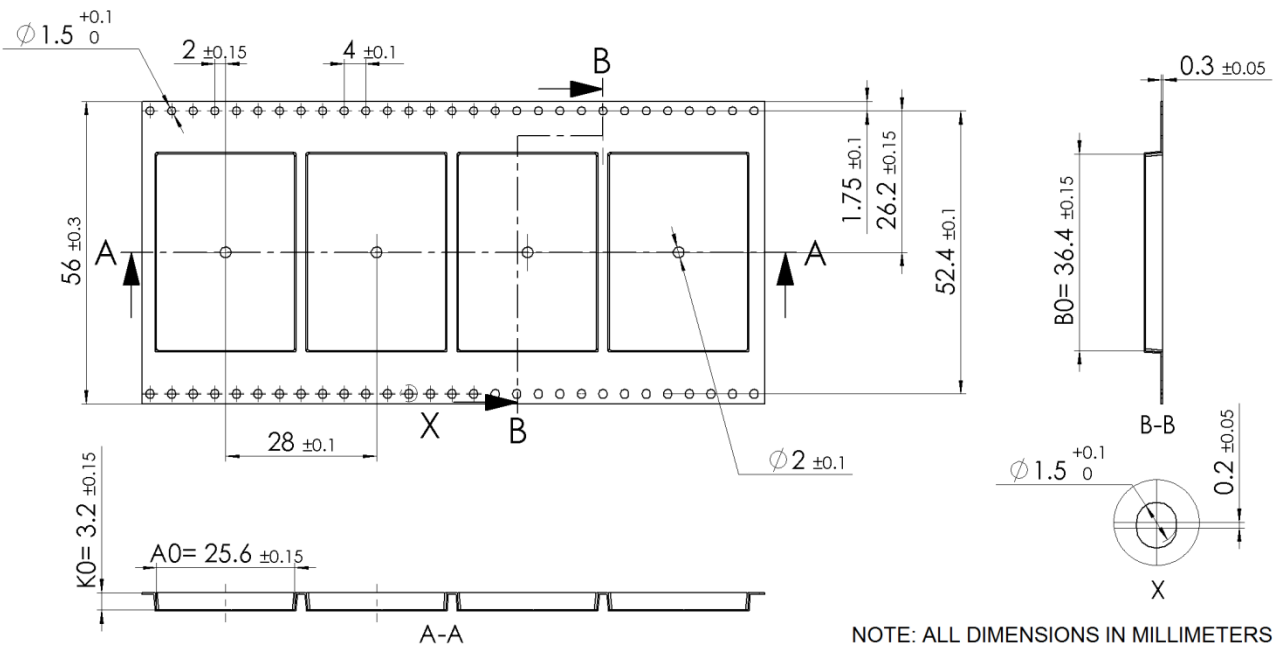



Figure 6: TOBY-R2 series modules tape

7.2 Moisture sensitivity levels

-  TOBY-R2 series modules are Moisture Sensitive Devices (MSD) in accordance to the IPC/JEDEC specification.

The Moisture Sensitivity Level (MSL) relates to the packaging and handling precautions required. TOBY-R2 series modules are rated at MSL level 4. For more information regarding moisture sensitivity levels, labeling, storage and drying, see the u-blox package information user guide [7].

-  For MSL standard, see IPC/JEDEC J-STD-020 (can be downloaded from www.jedec.org).

7.3 Reflow soldering

Reflow profiles are to be selected according to u-blox recommendations (see TOBY-R2 series system integration manual [2]).

-  Failure to observe these recommendations can result in severe damage to the device!

7.4 ESD precautions

-  TOBY-R2 series modules contain highly sensitive electronic circuitry and are Electrostatic Sensitive Devices (ESD). Handling TOBY-R2 series modules without proper ESD protection may destroy or damage them permanently.

TOBY-R2 series modules are Electrostatic Sensitive Devices (ESD) and require special ESD precautions typically applied to ESD sensitive components.

[Table 7](#) reports the maximum ESD ratings of the TOBY-R2 series modules.

Proper ESD handling and packaging procedures must be applied throughout the processing, handling and operation of any application that incorporates TOBY-R2 series module.

ESD precautions should be implemented on the application board where the module is mounted, as described in the TOBY-R2 series system integration manual [2].

-  Failure to observe these recommendations can result in severe damage to the device!

8 Default settings

Interface	AT settings	Comments	
UART interface	AT interface enabled	AT command mode is enabled by default on the UART physical interface	
	AT+IPR=0	One-shot automatic baud rate detection enabled	
	AT+ICF=3,1	Frame format: 8 bits, no parity, 1 stop bit	
		 Since AT+IPR=0 is the default value (one-shot automatic baud rate detection enabled), the AT+ICF value in the profile is not applied (AT+IPR=0 overrules the AT+ICF setting) and the one-shot automatic frame detection is active.	
	AT&K3	HW flow control enabled	
	AT&S1	DSR line set ON in data mode and set OFF in command mode	
	AT&D1	Upon an ON-to-OFF transition of DTR, the module enters online command state and issues an OK result code	
	AT&C1	Circuit 109 changes in accordance with the carrier detect status; ON if the carrier is detected, OFF otherwise	
USB interface	MUX disabled	Multiplexing mode can be enabled by +CMUX AT command providing following channels: <ul style="list-style-type: none"> • Channel 0: Multiplexer control • Channel 1 – 5: AT commands / data connection • Channel 6: GNSS data tunneling¹⁹ 	
	Enabled	6 USB CDCs (Communications Device Class) by default available: <ul style="list-style-type: none"> • USB1: AT and data • USB2: AT and data • USB3: AT and data • USB4: GNSS tunneling¹⁹ • USB5: SAP (SIM access profile)²⁰ • USB6: primary log (diagnostic purpose) 	
	AT&K3	HW flow control enabled	
	AT&S1	DSR line set ON in data mode and set OFF in command mode	
	AT&D1	Upon an ON-to-OFF transition of DTR, the module enters online command state and issues an OK result code	
	AT&C1	Circuit 109 changes in accordance with the carrier detect status; ON if the carrier is detected, OFF otherwise	
	Power saving	AT+UPSV=0	Disabled
	Network registration	AT+COPS=0	Self network registration

Table 36: TOBY-R2 series default settings

See the u-blox AT commands manual [\[1\]](#) and the TOBY-R2 series system integration manual [\[2\]](#) for information about further settings and factory-programmed values.

¹⁹ Not supported by TOBY-R200-02B-00, TOBY-R202-02B-00

²⁰ Not supported by "02B", "42B", "82B", or "03B" product versions

9 Labeling and ordering information

9.1 Product labeling

The labels of TOBY-R2 series modules include important product information as described in this section.

Figure 7 illustrates the label of all the TOBY-R2 series modules, and includes: u-blox logo, production lot, Pb-free marking, product type number, IMEI number, certifications' info, and production country.



Figure 7: TOBY-R2 series module label

9.2 Explanation of codes

Three different product code formats are used. The **Product Name** is used in documentation such as this data sheet and identifies all the u-blox products, independent of packaging and quality grade. The **Ordering Code** includes options and quality, while the **Type Number** includes the hardware and firmware versions. Table 37 details these 3 different formats:

Format	Structure
Product Name	PPPP-TGVV
Ordering Code	PPPP-TGVV-MMQ
Type Number	PPPP-TGVV-MMQ-XX

Table 37: Product code formats

Table 38 explains the parts of the product code.

Code	Meaning	Example
PPPP	Form factor	TOBY
TG	Platform (Technology and Generation) <ul style="list-style-type: none"> Dominant technology: G: GSM; U: HSUPA; C: CDMA 1xRTT; N: NB-IoT; R: LTE low data rate (Cat 1 and below); L: LTE high data rate (Cat 3 and above) Generation: 1...9 	R2
VV	Variant function set based on the same platform [00...99]	00
MM	Major product version [00...99]	02
Q	Product grade <ul style="list-style-type: none"> B = professional A = automotive 	B
XX	Minor product version (not relevant for certification)	Default value is 00

Table 38: Part identification code

9.3 Ordering information

Ordering number	Product
TOBY-R200-02B	Module supporting LTE Cat 1 bands 2 / 4 / 5 / 12, HSPA bands 1 / 2 / 5 / 8, (E)GPRS quad-band. Mainly designed for operation in North America. 35.6 x 24.8 x 2.6 mm, 150 pcs/reel
TOBY-R200-42B	Module supporting LTE Cat 1 bands 1 / 2 / 4 / 5 / 8 / 12, HSPA bands 1 / 2 / 5 / 8, (E)GPRS quad-band. Mainly designed for global coverage, primarily in North America. 35.6 x 24.8 x 2.6 mm, 150 pcs/reel
TOBY-R200-82B	Module supporting LTE Cat 1 bands 1 / 2 / 4 / 5 / 8 / 12, HSPA bands 1 / 2 / 5 / 8, (E)GPRS quad-band. Mainly designed for global coverage, primarily in North America. 35.6 x 24.8 x 2.6 mm, 150 pcs/reel
TOBY-R200-03B	Module supporting LTE Cat 1 bands 1 / 2 / 4 / 5 / 8 / 12, HSPA bands 1 / 2 / 5 / 8, (E)GPRS quad-band. Mainly designed for global coverage, primarily in North America. 35.6 x 24.8 x 2.6 mm, 150 pcs/reel
TOBY-R202-02B	Module supporting LTE Cat 1 bands 2 / 4 / 5 / 12, HSPA bands 2 / 5. Mainly designed for operation in North America. 35.6 x 24.8 x 2.6 mm, 150 pcs/reel

Table 39: Product ordering codes

Appendix

A Glossary

Abbreviation	Definition
ACM	Abstract Control Model
ADC	Analog to Digital Converter
ANATEL	Agência Nacional de Telecomunicações - National Telecommunications Agency (Brazil)
BB	Baseband
BER	Bit Error Rate
BIP	Bearer Independent Protocol
CBS	Cell Broadcast Services
CDC	Communication Device Class
CDMA	Code-Division Multiple Access
CLK	Clock
CMOS	Complementary Metal-Oxide-Semiconductor
CSFB	Circuit-Switched Fall-Back
CTS	Clear To Send
DC	Direct Current
DCD	Data Carrier Detect
DCE	Data Communication Equipment
DCS	Digital Cellular System
DDC	Display Data Channel
DL	Down Link (Reception)
DRX	Discontinuous Reception
DSR	Data Set Ready
DTE	Data Terminal Equipment
DTMF	Dual Tone Multi Frequency
DTR	Data Terminal Ready
EDGE	Enhanced Data rates for GSM Evolution
EGPRS	Enhanced General Packet Radio Service
ERS	External Reset Input Signal
ESD	Electrostatic Discharge
FCC	Federal Communications Commission United States
FDD	Frequency Division Duplex
FOAT	Firmware (update) Over AT commands
FOTA	Firmware (update) Over-The-Air
FTP	File Transfer Protocol
FW	Firmware
GDI	Generic Digital Interface
GERA	GSM EGPRS Radio Access
GMSK	Gaussian Minimum-Shift Keying modulation
GND	Ground
GNSS	Global Navigation Satellite System
GPIO	General Purpose Input/Output
GPRS	General Packet Radio Services
GSM	Global System for Mobile communications
HDLC	High-level Data Link Control
HSDPA	High Speed Downlink Packet Access
HSIC	High Speed Inter-Chip
HSPA	High Speed Packet Access

Abbreviation	Definition
HSUPA	High Speed Uplink Packet Access
HTTP	HyperText Transfer Protocol
HW	Hardware
I/O	Input/Output
I2C	Inter-Integrated Circuit
I2S	Inter-IC Sound
IC	Integrated Circuit
IEC	International Electrotechnical Commission
IMEI	International Mobile Equipment Identity
IMS	IP Multimedia System
IP	Internet Protocol
ISED	Innovation, Science and Economic Development (Canadian government)
ISO	International Organization for Standardization
ITU	International Telecommunications Union
LGA	Land Grid Array
LTE	Long-Term Evolution
M2M	Machine to Machine
ME	Mobile Equipment
MSD	Moisture Sensitive Device
MSL	Moisture Sensitivity Level
MUX	Multiplexer
N/A	Not Applicable
NCM	Network Control Model
PA	Power Amplifier
PCB	Printed Circuit Board
PCM	Pulse Code Modulation
PCN	Product Change Notification
PD	Pull-Down
PMU	Power Management Unit
PPS	Protocol and Parameter Selection
PTCRB	PCS Type Certification Review Board
PU	Pull-Up
PU/PD	Pull-Up/Pull-Down
QPSK	Quadrature Phase Shift Keying
RF	Radio Frequency
RI	Ring Indicator
RIL	Radio Interface Layer
RMC	Reference Measurement Channel
RTC	Real Time Clock
RTS	Request To Send
RX	Receive Signal
SAP	SIM Access Profile
SCL	Serial Clock
SDA	Serial Data
SDIO	Secure Digital Input Output
SIM	Subscriber Identity Module
SMS	Short Message Service
SSL	Secure Sockets Layer
TCP	Transmission Control Protocol
TCP/IP	Transmission Control Protocol/Internet Protocol
TDMA	Time-Division Multiple Access

Abbreviation	Definition
TLS	Transport Layer Security
TS	Technical Specification
TXD	Transmit Data
UART	Universal Asynchronous Receiver/Transmitter
UDP	User Datagram Protocol
UE	User Equipment
UL	Uplink (Transmission)
UMTS	Universal Mobile Telecommunications System
URC	Unsolicited Result Code
USB	Universal Serial Bus
WA	Word Alignment

Table 40: Explanation of the abbreviations and terms used

Related documentation

- [1] u-blox AT commands manual, [UBX-13002752](#)
- [2] u-blox TOBY-R2 series system integration manual, [UBX-16010572](#)
- [3] u-blox Android RIL source code application note, [UBX-13002041](#)
- [4] u-blox Windows Embedded RIL source code application note, [UBX-13002043](#)
- [5] u-blox GNSS implementation application note, [UBX-13001849](#)
- [6] u-blox mux implementation application note, [UBX-13001887](#)
- [7] u-blox package information user guide, [UBX-14001652](#)
- [8] 3GPP TS 27.007 - AT command set for User Equipment (UE)
- [9] 3GPP TS 27.005 - Use of Data Terminal Equipment - Data Circuit terminating Equipment (DTE - DCE) interface for Short Message Service (SMS) and Cell Broadcast Service (CBS)
- [10] 3GPP TS 27.010 - Terminal Equipment to User Equipment (TE-UE) multiplexer protocol
- [11] 3GPP TS 36.521-1 - Evolved Universal Terrestrial Radio Access; User Equipment conformance specification; radio transmission and reception; part 1: conformance testing
- [12] 3GPP TS 34.121-1 - User Equipment conformance specification; radio transmission and reception (FDD); part 1: conformance specification
- [13] 3GPP TS 51.010-1 - Mobile Station conformance specification; part 1: conformance specification
- [14] ITU-T recommendation V24, 02-2000. List of definitions for interchange circuits between Data Terminal Equipment (DTE) and Data Connection Equipment (DCE)
- [15] Universal Serial Bus revision 2.0 specification, <https://www.usb.org/>
- [16] I2C-bus specification and user manual – UM10204 – NXP semiconductors, <https://www.nxp.com/docs/en/user-guide/UM10204.pdf>
- [17] IEC 60079-0 - Explosive atmospheres, part 0: equipment general requirements
- [18] IEC 60079-11 - Explosive atmospheres, part 11: equipment protection by intrinsic safety 'i'
- [19] IEC 60079-26 - Explosive atmospheres, part 26: equipment with EPL Ga

 For regular updates to u-blox documentation and to receive product change notifications, register on our homepage (www.u-blox.com).

Revision history

Revision	Date	Name	Comments
R01	03-Mar-2016	sses	Initial release
R02	31-May-2016	sses	Improved description of VCC, power-on, reset, host select, UART, USB, GPIO pins
R03	11-Jul-2016	sses	Added current consumption and RF performance figures Remarked HSDPA category 8 Updated description of power-on, reset, host select, UART, USB pins
R04	22-Sep-2016	sses	Updated status to advance information Updated PWR_ON, ANT_DET, GPIO and clock output description. Added 2G current consumption figures.
R05	10-Oct-2016	lpah	Document reverted to objective specification TOBY-R200-02B prototypes information. Added remark in mechanical specifications.
R06	22-Dec-2016	sses	Document applicability updated to TOBY-R200 and TOBY-R202 Updated power-on and power-off sections.
R07	09-Feb-2017	sses	Updated GPRS / EDGE multi-slot class. Added AC characteristics of I2S pins and other minor characteristics.
R08	02-Mar-2017	sses	Updated extended VCC range of TOBY-R200 modules. Updated VUSB_DET pin logical levels input ranges.
R09	03-Aug-2017	sses	Extended document applicability to TOBY-R200-02B-01 / TOBY-R202-02B-01.
R10	22-May-2018	lpah	Extended document applicability to TOBY-R200-02B-02 / TOBY-R202-02B-02.
R11	02-Oct-2018	lpah	Added TOBY-R202 T-Mobile certification
R12	07-Dec-2018	lpah	Extended document applicability to TOBY-R200-02B-03 / TOBY-R202-02B-03.
R13	10-Jun-2019	lpah	Extended document applicability to TOBY-R200-02B-04 / TOBY-R202-02B-04. Revised RoHS and approval section. Added parameters for ATEX applications.
R14	30-Aug-2019	lpah / sses	Extended document applicability to TOBY-R200-42B / TOBY-R200-82B.
R15	16-Sep-2019	lpah	Updated the TOBY-R200-82B application version
R16	11-Oct-2019	lpah	Updated the TOBY-R200-42B product status
R17	25-Nov-2019	lpah	Updated the TOBY-R200-82B product status and audio interface support
R18	30-Mar-2021	sses	Extended document applicability to TOBY-R200-03B

Contact

For complete contact information, visit us at www.u-blox.com.

u-blox Offices

North, Central and South America

u-blox America, Inc.

Phone: +1 703 483 3180

Email: info_us@u-blox.com

Regional Office West Coast:

Phone: +1 408 573 3640

Email: info_us@u-blox.com

Technical Support:

Phone: +1 703 483 3185

Email: support@u-blox.com

Headquarters

Europe, Middle East, Africa

u-blox AG

Phone: +41 44 722 74 44

Email: info@u-blox.com

Support: support@u-blox.com

Asia, Australia, Pacific

u-blox Singapore Pte. Ltd.

Phone: +65 6734 3811

Email: info_ap@u-blox.com

Support: support_ap@u-blox.com

Regional Office Australia:

Phone: +61 3 9566 7255

Email: info_anz@u-blox.com

Support: support_ap@u-blox.com

Regional Office China (Beijing):

Phone: +86 10 68 133 545

Email: info_cn@u-blox.com

Support: support_cn@u-blox.com

Regional Office China (Chongqing):

Phone: +86 23 6815 1588

Email: info_cn@u-blox.com

Support: support_cn@u-blox.com

Regional Office China (Shanghai):

Phone: +86 21 6090 4832

Email: info_cn@u-blox.com

Support: support_cn@u-blox.com

Regional Office China (Shenzhen):

Phone: +86 755 8627 1083

Email: info_cn@u-blox.com

Support: support_cn@u-blox.com

Regional Office India:

Phone: +91 80 405 092 00

Email: info_in@u-blox.com

Support: support_in@u-blox.com

Regional Office Japan (Osaka):

Phone: +81 6 6941 3660

Email: info_jp@u-blox.com

Support: support_jp@u-blox.com

Regional Office Japan (Tokyo):

Phone: +81 3 5775 3850

Email: info_jp@u-blox.com

Support: support_jp@u-blox.com

Regional Office Korea:

Phone: +82 2 542 0861

Email: info_kr@u-blox.com

Support: support_kr@u-blox.com

Regional Office Taiwan:

Phone: +886 2 2657 1090

Email: info_tw@u-blox.com

Support: support_tw@u-blox.com