



SARA-R4 series

Multi-band LTE-M / NB-IoT / EGPRS modules

Data sheet



Abstract

Technical data sheet describing the size-optimized SARA-R4 series LTE-M / NB-IoT / EGPRS cellular modules, which are a complete and cost-efficient solution offering multi band data transmissions for Low Power Wide Area solutions in a compact form factor.

Document information

Title	SARA-R4 series	
Subtitle	Multi-band LTE-M / NB-IoT / EGPRS modules	
Document type	Data sheet	
Document number	UBX-16024152	
Revision and date	R25	02-Jul-2021
Disclosure restriction	C1-Public	

Product status	Corresponding content status	
Functional sample	Draft	For functional testing. Revised and supplementary data will be published later.
In development / Prototype	Objective specification	Target values. Revised and supplementary data will be published later.
Engineering sample	Advance information	Data based on early testing. Revised and supplementary data will be published later.
Initial production	Early production information	Data from product verification. Revised and supplementary data may be published later.
Mass production / End of life	Production information	Document contains the final product specification.

This document applies to the following products:

Product name	Type number	Modem version	Application version	PCN reference	Product status
SARA-R410M	SARA-R410M-01B-00	L0.0.00.00.02.03		UBX-18059854	Obsolete
	SARA-R410M-02B-00	L0.0.00.00.05.06	A02.00	UBX-18010263	Obsolete
		L0.0.00.00.05.06	A02.01	UBX-18070443	Obsolete
	SARA-R410M-02B-01	L0.0.00.00.05.08	A02.04	UBX-19041392	Mass production
	SARA-R410M-02B-02	L0.0.00.00.05.11	A.02.16	UBX-20033274	Mass production
	SARA-R410M-02B-03	L0.0.00.00.05.12	A.02.19	UBX-20058104	Initial production
	SARA-R410M-52B-00	L0.0.00.00.06.05	A02.06	UBX-18045915	Obsolete
	SARA-R410M-52B-01	L0.0.00.00.06.08	A02.11	UBX-19024506	Mass production
	SARA-R410M-52B-02	L0.0.00.00.06.11	A.02.16	UBX-20033274	Mass production
	SARA-R410M-63B-00	L0.08.12	A.01.11	UBX-20006293	End of life
	SARA-R410M-63B-01	L0.08.12	A.01.12	UBX-20053055	Initial production
	SARA-R410M-73B-00	L0.08.12	A.01.11	UBX-20006294	End of life
	SARA-R410M-73B-01	L0.08.12	A.01.12	UBX-20049254	Initial production
	SARA-R410M-83B-00	L0.08.12	A01.11	UBX-20027231	End of life
	SARA-R410M-83B-01	L0.08.12	A01.12	UBX-20049255	Initial production
SARA-R412M	SARA-R412M-02B-00	M0.09.00	A.02.11	UBX-19004091	Obsolete
	SARA-R412M-02B-01	M0.10.00	A.02.14	UBX-19016568	Mass production
	SARA-R412M-02B-02	M0.11.01	A.02.17	UBX-20031249	Mass production
	SARA-R412M-02B-03	M0.12.00	A.02.19	UBX-20058105	Initial production
SARA-R422	SARA-R422-00B-00	00.12	A00.00	UBX-21016086	Initial production
SARA-R422S	SARA-R422S-00B-00	00.12	A00.00	UBX-21016086	Initial production
SARA-R422M8S	SARA-R422M8S-00B-00	00.12	A00.00	UBX-21016086	Initial production

u-blox or third parties may hold intellectual property rights in the products, names, logos and designs included in this document. Copying, reproduction, modification or disclosure to third parties of this document or any part thereof is only permitted with the express written permission of u-blox.

The information contained herein is provided "as is" and u-blox assumes no liability for its use. No warranty, either express or implied, is given, including but not limited to, with respect to the accuracy, correctness, reliability and fitness for a particular purpose of the information. This document may be revised by u-blox at any time without notice. For the most recent documents, visit www.u-blox.com.

Copyright © u-blox AG.

Contents

Document information	2
Contents	3
1 Functional description	5
1.1 Overview.....	5
1.2 Product features.....	6
1.3 Block diagram.....	7
1.4 Product description.....	9
1.5 AT command support.....	11
1.6 Supported features.....	11
2 Interfaces	13
2.1 Power management.....	13
2.1.1 Module supply input (VCC).....	13
2.1.2 Generic digital interfaces supply output (V_INT).....	13
2.2 Antenna interface.....	13
2.2.1 Cellular antenna RF interface (ANT).....	13
2.2.2 GNSS antenna RF interface (ANT_GNSS).....	13
2.2.3 Antenna detection (ANT_DET).....	13
2.3 System functions.....	14
2.3.1 Module power-on.....	14
2.3.2 Module power-off.....	14
2.3.3 Module reset.....	14
2.4 SIM.....	15
2.4.1 SIM interface.....	15
2.4.2 SIM detection.....	15
2.5 Serial communication.....	15
2.5.1 UART interfaces.....	15
2.5.2 USB interface.....	16
2.5.3 SPI interface.....	17
2.5.4 SDIO interface.....	17
2.5.5 DDC (I2C) interface.....	17
2.6 Audio.....	18
2.7 GPIO.....	18
2.8 GNSS peripheral input output.....	19
3 Pin definition	20
3.1 Pin assignment.....	20
4 Electrical specifications	25
4.1 Absolute maximum rating.....	25
4.1.1 Maximum ESD.....	25
4.2 Operating conditions.....	26
4.2.1 Operating temperature range.....	26

4.2.2	Thermal parameters	26
4.2.3	Supply/power pins	26
4.2.4	Current consumption.....	27
4.2.5	GNSS characteristics.....	28
4.2.6	LTE RF characteristics	29
4.2.7	2G RF characteristics	31
4.2.8	ANT_DET pin.....	31
4.2.9	PWR_ON pin.....	31
4.2.10	PWR_CTRL pin	32
4.2.11	RESET_N pin.....	32
4.2.12	SIM pins	32
4.2.13	USB pins	32
4.2.14	DDC (I2C) pins.....	33
4.2.15	Generic digital interfaces pins	33
4.2.16	GNSS digital interfaces pins	33
4.3	Parameters for ATEX applications.....	34
5	Mechanical specifications	35
6	Qualification and approvals.....	36
6.1	Approvals.....	36
6.2	Reliability tests.....	39
7	Product handling & soldering.....	40
7.1	Packaging	40
7.1.1	Reels	40
7.1.2	Tapes.....	41
7.2	Moisture Sensitivity Levels.....	42
7.3	Reflow soldering	42
7.4	ESD precautions.....	42
8	Labeling and ordering information	43
8.1	Product labeling.....	43
8.2	Explanation of codes	43
8.3	Ordering information.....	44
Appendix	45
A	Glossary	45
Related documentation	47
Revision history	47
Contact		49

1 Functional description

1.1 Overview

The SARA-R4 series modules are a multi-band LTE-M / NB-IoT / EGPRS multi-mode solution in the miniature SARA LGA form factor (26.0 x 16.0 mm, 96-pin). They allow an easy integration into compact designs and a seamless drop-in migration from other u-blox cellular module families.

SARA-R4 series modules provide software-based multi-band configurability enabling international multi-regional coverage in LTE-M / NB-IoT and (E)GPRS radio access technologies.

SARA-R4 series modules offer data communications over an extended operating temperature range of $-40\text{ }^{\circ}\text{C}$ to $+85\text{ }^{\circ}\text{C}$, with low power consumption, and with coverage enhancement for deeper range into buildings and basements (and underground with NB-IoT).

SARA-R4 series modules are form-factor compatible with the u-blox LISA, LARA and TOBY cellular module families and are pin-to-pin compatible with the u-blox SARA-N, SARA-G and SARA-U cellular module families. This facilitates migration from other u-blox LPWA, GSM/GPRS, CDMA, UMTS/HSPA and higher LTE categories modules, maximizing customer investments, simplifying logistics, and enabling very short time-to-market.

With many interface options and an integrated IP stack, SARA-R4 series modules are the optimal choice for LPWA applications with low to medium data throughput rates, as well as devices that require long battery lifetimes, such as used in smart metering, smart lighting, telematics, asset tracking, remote monitoring, alarm panels, and connected health.

Secure cloud product versions are available within the SARA-R4 series modules, including a unique and immutable root-of-trust. This provides the foundation for a trusted set of advanced security functionalities. The scalable, pre-shared key management system offers best-in-class data encryption and decryption, both on-device as well as from device-to-cloud. Utilizing the latest (D)TLS stack and cipher suites with hardware-based crypto acceleration provides robust, efficient, and protected communication.

Furthermore, the SARA-R422 series modules support a comprehensive set of 3GPP Rel. 14 features for LTE Cat M1 and Cat NB2 that are relevant for IoT applications.

The dedicated SARA-R422M8S module is pre-integrated with the u-blox M8 GNSS receiver chip and a separate GNSS antenna interface which provides highly reliable, accurate positioning data simultaneously with LTE communication. In addition, the module offers unique hybrid positioning, in which the GNSS position is enhanced with u-blox CellLocate[®] data, providing location always and everywhere.

Customers can future-proof their solutions by means of Over-The-Air firmware updates, thanks to the uFOTA client/server solution that utilizes LWM2M, a light and compact protocol ideal for IoT.

SARA-R4 series modules will also support VoLTE over Cat M1 and CSFB over 2G. The flexibility extends further through dynamic mode selection as M1-only/preferred or NB-IoT-only/preferred.

1.3 Block diagram

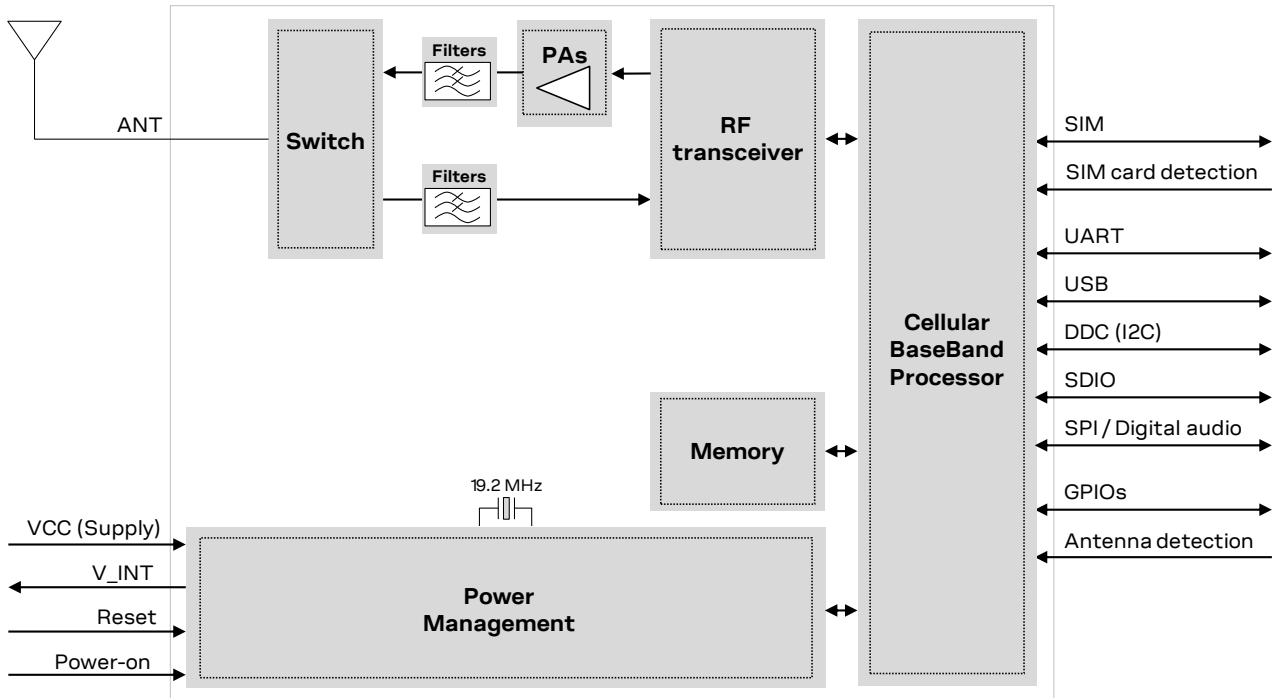

Figure 1: SARA-R410M and SARA-R412M modules' simplified block diagram

The SARA-R410M-01B modules, i.e. the “01B” product versions of these SARA-R4 series modules, do not support the following interfaces, which should be left unconnected and should not be driven by external devices:

- DDC (I2C) interface
- SDIO interface
- SPI interface
- Digital audio interface

The SARA-R410M-02B, the SARA-R410M-52B, the SARA-R410M-63B, the SARA-R410M-73B, the SARA-R410M-83B, and the SARA-R412M-02B modules, i.e. the “02B”, “52B”, “63B”, “73B”, and “83B” product versions of these SARA-R4 series modules, do not support the following interfaces, which should be left unconnected and should not be driven by external devices:

- SDIO interface
- SPI interface
- Digital audio interface

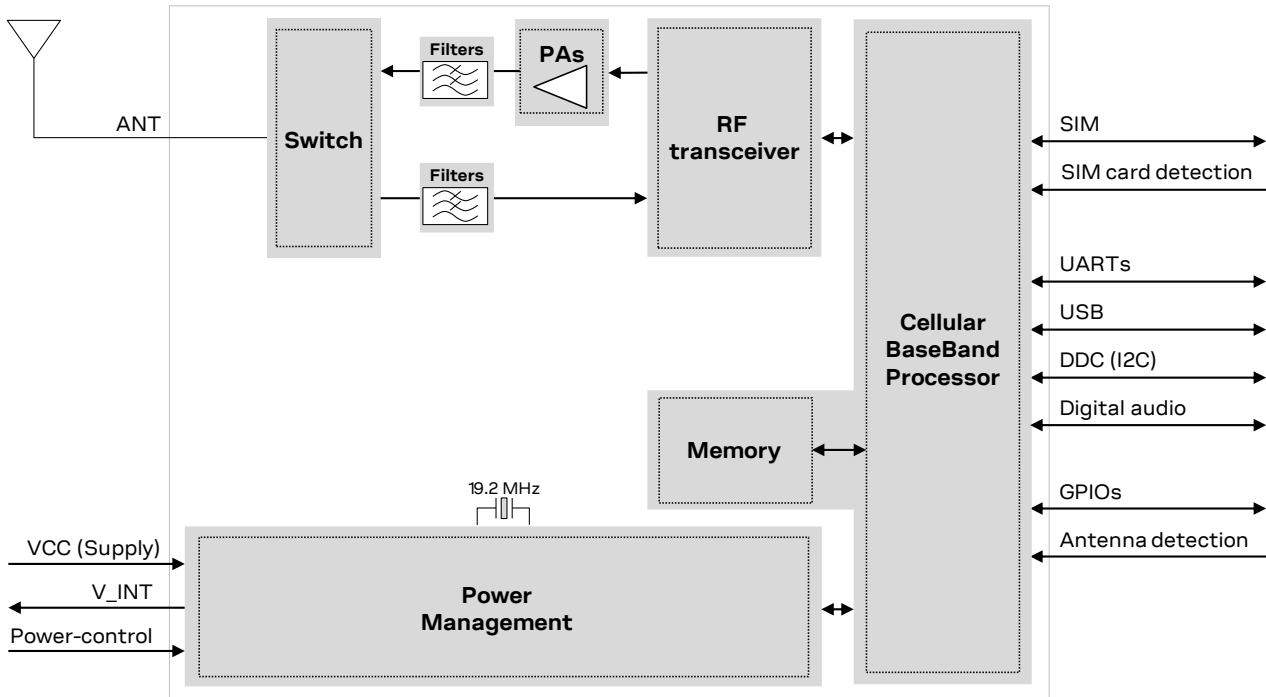

Figure 2: SARA-R422 and SARA-R422S modules' simplified block diagram

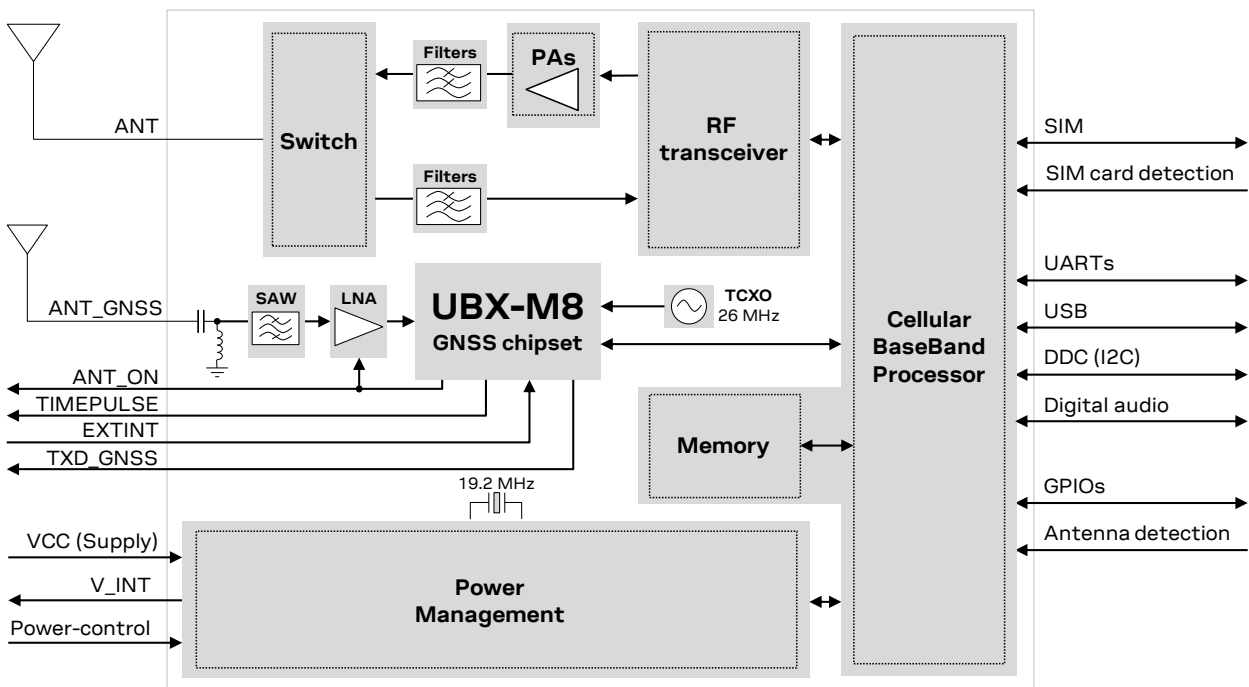



Figure 3: SARA-R422M8S modules' simplified block diagram

 The SARA-R422-00B, the SARA-R422S-00B and the SARA-R422M8S-00B modules, i.e. the “00B” product versions of these SARA-R4 series modules, do not support the following interfaces, which should be left unconnected and should not be driven by external devices:

- Digital audio interface

1.4 Product description

SARA-R4 series modules include the following variants / product versions:

- SARA-R410M-01B LTE Cat M1 module,
mainly designed for operation in LTE bands 2, 4, 5, 12
- SARA-R410M-02B LTE Cat M1 / NB1 module,
mainly designed for operation in LTE bands 1, 2, 3, 4, 5, 8, 12, 13, 18, 19, 20, 25, 26, 28
- SARA-R410M-52B LTE Cat M1 module,
mainly designed for operation in LTE bands 2, 4, 5, 12, 13
- Secure Cloud SARA-R410M-63B LTE Cat M1 module,
mainly designed for operation in LTE bands 1, 8, 19
- Secure Cloud SARA-R410M-73B LTE Cat M1 module,
mainly designed for operation in LTE bands 3, 5, 26
- Secure Cloud SARA-R410M-83B LTE Cat M1 / NB1 module,
mainly designed for operation in LTE bands 3, 5, 8, 20, 28

- SARA-R412M-02B LTE Cat M1 / NB1 and 2G module,
mainly designed for operation in LTE bands 2, 3, 4, 5, 8, 12, 13, 20, 28 and 2G 4-band

- SARA-R422 LTE Cat M1 / NB2 and 2G module,
designed for operation in LTE bands 1, 2, 3, 4, 5, 8, 12, 13, 20, 25, 26, 28, 66, 85 and 2G 4-band
- Secure Cloud SARA-R422 LTE Cat M1 / NB2 and 2G module,
designed for operation in LTE bands 1, 2, 3, 4, 5, 8, 12, 13, 20, 25, 26, 28, 66, 85 and 2G 4-band
- Secure Cloud SARA-R422M8 LTE Cat M1 / NB2 and 2G module, integrating the UBX-M8 GNSS,
designed for operation in LTE bands 1, 2, 3, 4, 5, 8, 12, 13, 20, 25, 26, 28, 66, 85 and 2G 4-band

[Table 2](#) summarizes cellular radio access technologies characteristics and features supported by the SARA-R4 series modules.

 See [Table 32](#) and [Table 33](#) for the detailed list of RATs and bands included in each certification approval of the SARA-R4 series modules product versions.

	SARA-R410M	SARA-R412M	SARA-R422 / -R422S / -R422M8S
Protocol stack	3GPP Release 13	3GPP Release 13	3GPP Release 14
RAT	LTE Cat M1 LTE Cat NB1 ^{1,3,4,6}	LTE Cat M1 LTE Cat NB1 2G GPRS / EGPRS	LTE Cat M1 LTE Cat NB1 2G GPRS / EGPRS
LTE FDD bands	Band 1 (2100 MHz) ^{1,4,7} Band 2 (1900 MHz) ^{6,7} Band 3 (1800 MHz) ^{1,4} Band 4 (1700 MHz) ^{6,7} Band 5 (850 MHz) Band 8 (900 MHz) ^{1,4} Band 12 (700 MHz) ^{6,7} Band 13 (750 MHz) ^{1,6,7} Band 18 (850 MHz) ^{1,3,4,6,7} Band 19 (850 MHz) ^{1,3,4,7} Band 20 (800 MHz) ^{1,4,6} Band 25 (1900 MHz) ^{1,2,3,4,5,6,7} Band 26 (850 MHz) ^{1,3,4,7} Band 28 (700 MHz) ^{1,4,6}	Band 2 (1900 MHz) Band 3 (1800 MHz) Band 4 (1700 MHz) Band 5 (850 MHz) Band 8 (900 MHz) Band 12 (700 MHz) Band 13 (750 MHz) Band 20 (800 MHz) Band 26 (850 MHz) ⁸ Band 28 (700 MHz) ⁸	Band 1 (2100 MHz) Band 2 (1900 MHz) Band 3 (1800 MHz) Band 4 (1700 MHz) Band 5 (850 MHz) Band 8 (900 MHz) Band 12 (700 MHz) Band 13 (750 MHz) Band 20 (800 MHz) Band 25 (1900 MHz) Band 26 (850 MHz) Band 28 (700 MHz) Band 66 (1700 MHz) Band 85 (700 MHz)
2G bands		GSM 850 MHz E-GSM 900 MHz DCS 1800 MHz PCS 1900 MHz	GSM 850 MHz E-GSM 900 MHz DCS 1800 MHz PCS 1900 MHz
Power class	LTE Cat M1 / NB1 ⁹ : Class 3 (23 dBm)	LTE category M1 / NB1: Class 3 (23 dBm) 2G GMSK: Class 4 (33 dBm) in 850/900, Class 1 (30 dBm) in 1800/1900 2G 8-PSK: Class E2 (27 dBm) in 850/900, Class E2 (26 dBm) in 1800/1900	LTE category M1 / NB2: Class 3 (23 dBm) 2G GMSK: Class 4 (33 dBm) in 850/900, Class 1 (30 dBm) in 1800/1900 2G 8-PSK: Class E2 (27 dBm) in 850/900, Class E2 (26 dBm) in 1800/1900
Data rate	LTE category M1: up to 375 kb/s UL, 300 kb/s DL LTE category NB1 ⁹ : up to 62.5 kb/s UL, 27.2 kb/s DL	LTE category M1: up to 375 kb/s UL, 300 kb/s DL LTE category NB1: up to 62.5 kb/s UL, 27.2 kb/s DL GPRS multi-slot class 33 ¹⁰ : up to 85.6 kb/s UL, 107 kb/s DL EGPRS multi-slot class 33 ¹⁰ : up to 236.8 kb/s UL, 296 kb/s DL	LTE Cat M1: up to 1119 kbit/s UL, 588 kbit/s DL LTE Cat NB2: up to 158.5 kbit/s UL, 127 kbit/s DL GPRS multi-slot class 33 ¹⁰ : up to 85.6 kb/s UL, 107 kb/s DL EGPRS multi-slot class 33 ¹⁰ : up to 236.8 kb/s UL, 296 kb/s DL
GNSS receiver			SARA-R422M8S only: 72-channel u-blox M8 engine GPS L1C/A, SBAS L1C/A, QZSS L1C/A, QZSS L1-SAIF, GLONASS L10F, BeiDou B1I, Galileo E1B/C

Table 2: SARA-R4 series modules cellular and GNSS characteristics summary
¹ Not supported by the SARA-R410M-01B product version.

² Not supported by the SARA-R410M-02B-00 product version.

³ Not supported by the SARA-R410M-52B-00 product version.

⁴ Not supported by the SARA-R410M-52B-01, or SARA-R410M-52B-02 product versions.

⁵ Not supported in LTE Cat NB1 by the SARA-R410M-02B-01, SARA-R410M-02B-02, or SARA-R410M-02B-03 versions.

⁶ Not supported by the SARA-R410M-63B or SARA-R410M-73B product versions.

⁷ Not supported by the SARA-R410M-83B product version.

⁸ Not supported by the SARA-R412M-02B-00 product version.

⁹ LTE Cat NB1 not supported by SARA-R410M-01B, SARA-R410M-52B, SARA-R410M-63B, or SARA-R410M-73B versions.

¹⁰ GPRS/EGPRS multi-slot class 33 implies a maximum of 5 slots in Down-Link and 4 slots in Up-Link with 6 slots in total.

1.5 AT command support

The SARA-R4 series modules support AT commands according to the 3GPP standards TS 27.007 [8], TS 27.005 [9], TS 27.010 [10], and the u-blox AT command extension.

 For the complete list of all supported AT commands and their syntax, see the SARA-R4 series AT commands manual [1].

1.6 Supported features

Table 3 lists some of the main features supported by SARA-R4 series modules. For more details, see the SARA-R4 series system integration manual [2] and the SARA-R4 series AT commands manual [1].

Feature	Description
Network indication	GPIO configured to indicate the network status: registered home network, registered roaming, data call enabled, no service. The feature can be enabled through the +UGPIOC AT command.
Antenna detection	The ANT_DET pin provides antenna presence detection capability, evaluating the resistance from the ANT pin to GND by means of an external antenna detection circuit implemented on the application board. The antenna supervisor (i.e. antenna detection) feature can be enabled through the +UANTR AT command.
Embedded TCP and UDP stack	Embedded TCP/IP and UDP/IP stack including direct link mode for TCP and UDP sockets. Sockets can be set in Direct Link mode to establish a transparent end-to-end communication with an already connected TCP or UDP socket via the serial interface.
FTP	File Transfer Protocol functionality is supported via AT commands.
HTTP	Hyper-Text Transfer Protocol functionality is supported via AT commands.
Embedded SSL/TLS	With the support of X.509 certificates, embedded SSL/TLS provides server and client authentication, data encryption, data signature and enables TCP/IP applications to communicate over a secured and trusted connection. The feature can be configured and enabled by the +USECMNG and +USECPRF AT commands.
Device and data security ¹¹	Device security: authentication, updates. Data security: PSK, E2E encryption, local encryption. For more details, see the security suite application note [4].
MQTT ¹²	Message Queuing Telemetry Transport is an ISO standard publish-subscribe messaging protocol designed for lightweight M2M communications over TCP. MQTT allows clients to communicate one-to-one, one-to-many and many-to-one over a long-lived outgoing TCP connection.
BIP ¹²	Bearer Independent Protocol for Over-the-Air SIM provisioning.
Dual stack IPv4/IPv6	Capability to move between IPv4 and dual stack network infrastructures. IPv4 and IPv6 addresses can be used.
MNO profiles ¹²	Mobile network operator profiles provide with a powerful and flexible method to configure the SARA-R4 series modules to seamlessly work with the selected mobile network operator. Using the MNO profiles the device is dynamically configured to use the proper bands, RATs, power saving parameters, e-DRX parameters and the protocol stack settings needed to operate on the selected network in full compliance with operator requirements. Use the +UMNOPROF AT command to select a profile for the network operator.
Firmware update Over AT commands (FOAT)	Firmware module update over AT command interface. The feature can be enabled and configured through the +UFWUPD AT command.
Firmware update Over The Air (uFOTA)	u-blox firmware module update over the LTE air interface client/server solution using LwM2M.

¹¹ Not supported by SARA-R410M-01B, SARA-R410M-02B, SARA-R410M-52B, or SARA-R412M-02B product versions.

¹² Not supported by SARA-R410M-01B product version.

Feature	Description
Integrated GNSS receiver ¹³	SARA-R422M8S modules are pre-integrated with a u-blox M8 GNSS receiver chip-down design, comprehensive of a dedicated GNSS antenna interface, LNA and SAW filter for a highly reliable, accurate positioning data. The GNSS system is totally independent from the LTE system and can run concurrently to a LTE communication.
External GNSS access and control via modem ¹⁴	Full access to external u-blox positioning chips and modules is available through I2C interface. This means that from any host processor, a single serial port can control the SARA-R4 series cellular module and the separated u-blox positioning chip or module.
CellLocate ¹⁵	Enables the estimation of device position based on the parameters of the mobile network cells visible to the specific device based on the CellLocate® database. CellLocate® is available via a set of AT commands for CellLocate® service configuration and position request.
Power Saving Mode (PSM)	The Power Saving Mode (PSM) feature, defined in 3GPP Rel.13, allows further reduction of the module current consumption maximizing the amount of time a device can remain in PSM low power deep sleep mode during periods of data inactivity. It can be activated and configured by the +CPSMS AT command.
e-I-DRX ¹⁶	Extended Idle mode DRX, based on 3GPP Rel.13, reduces the amount of signaling overhead decreasing the frequency of scheduled measurements and/or transmissions performed by the module in idle mode. This in turn leads to a reduction in the module power consumption while maintaining a perpetual connection with the base station.
Coverage Enhancements Mode A	Coverage Enhancements (CE) Mode A, introduced in 3GPP Rel.13, is used to improve cell signal penetration.
Coverage Enhancements Mode B ¹⁷	Coverage Enhancements (CE) Mode B, introduced in 3GPP Rel.13, is used to further improve cell signal penetration.
Connected Mode Mobility ¹⁸	LTE Cat M1 Connected Mode Mobility (CMM) with CE Mode A
Release Assistance Indicator ¹⁸	The 3GPP Release Assistance feature allows the module to request for the RRC connection to be dropped as soon as the message has been received by the network. This feature allows a reduction in the module power consumption.
LwM2M with dynamically loaded objects ¹⁹	Method allowing dynamically loaded run time objects for customers to configure u-blox modules to define necessary objects, create instances of those objects as appropriate, manage module LwM2M protocol stack to interact with the LwM2M server.
Backup and restore ²⁰	This feature allows the modules to autonomously restore the flash file system using the last backup stored on the module itself. For further details about the backup and restore feature, see the +UBKUPDATA AT command description in the SARA-R4 series AT commands manual [1], and the backup and restore technical note [5].

Table 3: Some of the main features supported by SARA-R4 series modules

 u-blox is extremely mindful of user privacy. When a position is sent to the CellLocate® server, u-blox is unable to track the SIM used or the specific device.

¹³ Not supported by SARA-R410M, SARA-R412M, SARA-R422, or SARA-R422S modules

¹⁴ Not supported by SARA-R410M-01B, SARA-R422, or SARA-R422M8S product versions

¹⁵ Not supported by SARA-R410M-01B, SARA-R410M-02B-00, SARA-R410M-02B-01, SARA-R410M-02B-02, SARA-R410M-52B, SARA-R412M-02B-00, SARA-R412M-02B-01, SARA-R412M-02B-02, or SARA-R422 product versions

¹⁶ The feature is disabled on SARA-R410M-01B product versions due to network readiness

¹⁷ Not supported by current product versions

¹⁸ Not supported by SARA-R410M-01B, SARA-R410M-02B, SARA-R410M-52B, or SARA-R412M-02B product versions

¹⁹ Not supported by SARA-R410M-01B, SARA-R410M-02B-00, SARA-R410M-02B-01, SARA-R410M-02B-02, SARA-R410M-52B, SARA-R412M-02B-00, SARA-R412M-02B-01, or SARA-R412M-02B-02 product versions

²⁰ Not supported by SARA-R410M-01B, SARA-R410M-02B-00, SARA-R410M-02B-01, SARA-R410M-02B-02, SARA-R410M-52B, SARA-R410M-63B, SARA-R410M-73B, SARA-R410M-83B, SARA-R412M-02B-00, SARA-R412M-02B-01, or SARA-R412M-02B-02 product versions

2 Interfaces

2.1 Power management

2.1.1 Module supply input (VCC)

SARA-R4 series modules must be supplied through the **VCC** pins by a DC power supply. Voltage must be stable, because during operation the current drawn from **VCC** may vary significantly, based on the power consumption profile of the LTE-M, NB-IoT and the 2G radio access technologies (described in the SARA-R4 series system integration manual [2]).

SARA-R412M, SARA-R422, SARA-R422S, and SARA-R422M8S modules, which support 2G radio access technology, provide separate supply inputs over the three **VCC** pins:

- **VCC** pins #52 and #53 represent the supply input for the internal RF Power Amplifier, demanding most of the total current drawn of the module when RF transmission is enabled during a call
- **VCC** pin #51 represents the supply input for the internal baseband Power Management Unit, demanding minor part of the total current drawn of the module when RF transmission is enabled during a call

The three **VCC** pins of the SARA-R410M modules are internally connected to both the internal Power Amplifier and the internal baseband Power Management Unit.

It is important that the system power supply circuit is able to withstand the maximum pulse current during a transmit burst at maximum power level (see Table 12).

2.1.2 Generic digital interfaces supply output (V_INT)

SARA-R4 series modules provide a 1.8 V supply rail output on the **V_INT** pin, which is internally generated when the module is switched on. The same voltage domain is used internally to supply the generic digital interfaces of the module. The **V_INT** supply output can be used in place of an external discrete regulator.

2.2 Antenna interface

2.2.1 Cellular antenna RF interface (ANT)

The **ANT** pin is the cellular RF antenna I/O interface, designed with 50 Ω characteristic impedance.

2.2.2 GNSS antenna RF interface (ANT_GNSS)

 The GNSS antenna RF interface is not supported by SARA-R410M, SARA-R412M, SARA-R422, or SARA-R422S modules.

The **ANT_GNSS** pin represents the GNSS RF input of the SARA-R422M8S modules, designed with 50 Ω characteristic impedance and with an internal DC block, suitable for both active and/or passive GNSS antennas due to the built-in SAW filter followed by an LNA in front of the integrated high performing u-blox M8 concurrent positioning engine.

2.2.3 Antenna detection (ANT_DET)

The **ANT_DET** pin is an Analog to Digital Converter (ADC) input with a current source provided by SARA-R4 series modules to sense the antenna presence (as an optional feature). It evaluates the resistance from the **ANT** pin to GND by means of an external antenna detection circuit implemented on the application board (for more details, see the u-blox SARA-R4 series system integration manual [2] and the SARA-R4 series AT commands manual [1]).

2.3 System functions

2.3.1 Module power-on

SARA-R4 series modules can be properly switched on by:

- Low level on the **PWR_ON** pin, which is normally set high by an internal pull-up, for a valid time period, when the applied **VCC** voltage is within the valid operating range (see sections [4.2.3](#), [4.2.9](#)). The **PWR_ON** line has to be driven by open drain, open collector or contact switch.
- Low level on the **PWR_CTRL** pin, which is normally set high by an internal pull-up, for a valid time period, when the applied **VCC** voltage is within the valid operating range (see sections [4.2.3](#), [4.2.10](#)). The **PWR_CTRL** line has to be driven by open drain, open collector or contact switch.

2.3.2 Module power-off

SARA-R4 series modules can be properly switched off, with storage of the current parameter settings in the module's internal non-volatile memory and a clean network detach, in one of these ways:

- AT+CPWROFF command (see the SARA-R4 series AT commands manual [\[1\]](#))
- Low pulse on the **PWR_ON** pin for a valid time period (see section [4.2.9](#))
- Low pulse on the **PWR_CTRL** pin for a valid time period (see section [4.2.10](#))

A faster and safe power-off procedure of SARA-R422, SARA-R422S, SARA-R422M8S modules, with storage of the current parameter settings in the module's internal non-volatile memory and without proper network detach, can be triggered by:

- AT+CFUN=10 command (see the SARA-R4 series AT commands manual [\[1\]](#))
- Toggling the GPIO input pin configured with the fast and safe power-off function (see section [2.7](#))

An abrupt shutdown occurs on SARA-R4 series modules, without storage of the current parameter settings and without a clean network detach, when:

- The **VCC** supply drops below the extended operating range minimum limit
- Low level on the **RESET_N** pin, which is normally set high by an internal pull-up, for a valid time period (see [4.2.11](#)). **RESET_N** line has to be driven by open drain, open collector or contact switch.

SARA-R4 series modules automatically switch off, with storage of the current parameter settings in the module's internal non-volatile memory and a clean network detach, after having sent the last gasp, once the feature is enabled and triggered (see the SARA-R4 series AT commands manual [\[1\]](#), +ULGASP AT command).

2.3.3 Module reset

SARA-R4 series modules can be reset (re-booted) by:

- AT+CFUN=15 command (see the SARA-R4 series AT commands manual [\[1\]](#) for detailed options). This causes an "internal" or "software" reset of the module. The current parameter settings are saved in the module's internal non-volatile memory and a clean network detach is performed.

An abrupt emergency reset (reboot) is triggered on the SARA-R422, SARA-R422S, SARA-R422M8S modules, without storage of current parameter settings and without a clean network detach, when:

- a low level is applied on the **PWR_CTRL** pin for a valid time period (see section [4.2.10](#))

2.4 SIM

2.4.1 SIM interface

SARA-R4 series modules provide a SIM interface on the **VSIM**, **SIM_IO**, **SIM_CLK**, **SIM_RST** pins to connect an external SIM card or UICC chip.

SARA-R410M and SARA-R412M modules support both 1.8 V and 3.0 V types of SIM / UICC, with automatic voltage switch implemented according to related specifications.

SARA-R422, SARA-R422S and SARA-R422M8S modules support only the 1.8 V type of SIM / UICC.

2.4.2 SIM detection

The **GPIO5** pin of SARA-R4 series modules is a 1.8 V digital input which can be configured as an external interrupt to detect the SIM card presence, as intended to be properly connected to the mechanical switch of an external SIM card holder. For more details, see the SARA-R4 series system integration manual [2] and the SARA-R4 series AT commands manual [1].

2.5 Serial communication

The SARA-R4 series provides the following serial communication interfaces:

- UART interfaces: asynchronous serial interface available for the communication with a DTE host application processor (AT commands, data communication, FW update by means of FOAT)
- USB interface: High-Speed USB 2.0 interface available to connect an external USB host application processor (for AT commands²¹, data communication²¹, FW update by means of FOAT feature²¹), for FW update by means of the u-blox tool and for diagnostics
- SPI interface²²: Serial Peripheral Interface for communications with an external compatible device
- SDIO interface²²: Secure Digital Input Output interface for communications with external device
- DDC interface: I2C-compatible interface available for communications with external I2C devices

2.5.1 UART interfaces

SARA-R4 series modules include a primary UART interface (UART) for communication with an application host processor, supporting AT commands, data communication, multiplexer protocol functionality, FW update by means of FOAT, with settings configurable by dedicated AT commands (for more details, see the SARA-R4 series AT commands manual [1]):

- 8-wire serial port with RS-232 functionality conforming to ITU-T V.24 recommendation [13], with CMOS compatible signal levels (0 V for low data bit / ON state, 1.8 V for high data bit / OFF state)
 - Data lines (**RXD** as data output, **TXD** as data input)
 - HW flow control lines (**CTS** as flow control output, **RTS** as flow control input)
 - Modem status and control lines (**DTR** input, **DSR** output, **DCD** output, **RI** output)²³
- The default baud rate is 115200 b/s
- The default frame format is 8N1 (8 data bits, no parity, 1 stop bit)

 The UART is available only if the USB is not enabled as an AT command / data communication interface: UART and USB cannot be concurrently used for this purpose.

 HW flow control is not supported by the SARA-R410M-01B or the SARA-R410M-02B-00, and the **RTS** input has to be set low (= ON) to communicate over the UART on the SARA-R410M-01B.

²¹ Not supported by SARA-R422-00B, SARA-R422S-00B or SARA-R422M8S-00B modules

²² Not supported by the current product versions of SARA-R410M and SARA-R412M modules. Not available on SARA-R422, SARA-R422S and SARA-R422M8S modules.

²³ **DTR**, **DSR**, **DCD** and **RI** pins can be alternatively configured, in a mutually exclusive way, as secondary auxiliary UART interface (UART AUX) on SARA-R422, SARA-R422S and SARA-R422M8S modules.

SARA-R422, SARA-R422S, SARA-R422M8S modules include a secondary auxiliary UART interface (UART AUX) for communication with an application host processor, supporting AT commands, data communication, GNSS tunneling²⁴, FW update by means of FOAT, with settings configurable by dedicated AT commands (for more details, see the SARA-R4 series AT commands manual [1]):

- 4-wire serial port with RS-232 functionality conforming to ITU-T V.24 recommendation [13], with CMOS compatible signal levels (0 V for low data bit / ON state, 1.8 V for high data bit / OFF state)
 - Data lines (**DCD** as data output, **DTR** as data input)
 - HW flow control lines (**RI** as flow control output, **DSR** as flow control input)
- The default baud rate is 115200 b/s
- The default frame format is 8N1 (8 data bits, no parity, 1 stop bit)

2.5.1.1 Multiplexer protocol

SARA-R4 series modules include multiplexer functionality as per 3GPP TS 27.010 [10] on the primary UART physical link. This is a data link protocol which uses HDLC-like framing and operates between the module (DCE) and the application processor (DTE), allowing simultaneous sessions over the primary UART physical link. The following virtual channels are defined:

- Channel 0: for multiplexer control
- Channel 1: for all AT commands, and non-Dial Up Network (non-DUN) data connections. UDP, TCP data socket / data call connections through relevant AT commands.
- Channel 2: for Dial Up Network (DUN) data connection. It requires the host to have and use its own TCP/IP stack. The DUN can be initiated on the modem side or terminal/host side.
- Channel 3: for u-blox GNSS data tunneling (not supported by SARA-R410M-01B or SARA-R422-00B product versions).

2.5.2 USB interface

SARA-R4 series modules include a high-speed USB 2.0 compliant interface with a maximum 480 Mb/s data rate according to the USB 2.0 specification [14]. The module itself acts as a USB device and can be connected to any USB host equipped with compatible drivers.

The USB is the most suitable interface for transferring high speed data between the SARA-R410M and SARA-R412M modules and an external host processor, available for AT and data communication, FW upgrade by means of the FOAT feature.

The USB is the interface of SARA-R4 series modules available for FW upgrade by means of the u-blox dedicated tool and for diagnostic purposes.

SARA-R410M and SARA-R412M modules provide the following USB lines:



- the **USB_D+** / **USB_D-** lines, carrying the USB data and signaling
- the **VUSB_DET** input pin to enable the USB interface by applying an external voltage (5.0 V typical)

SARA-R422, SARA-R422S and SARA-R422M8S modules provide the following USB lines:

- the **USB_D+** / **USB_D-** lines, carrying the USB data and signaling
- the **USB_5V0** input pin to enable the USB interface by applying an external voltage (5.0 V typical)
- the **USB_3V3** input pin to supply the USB interface by applying an external 3.3 V typical voltage
- the **RSVD #33** pin to be externally accessible to enable FW upgrade over the USB interface

 The USB interface is available as an AT / data communication interface on the SARA-R410M and SARA-R412M modules only if an external valid USB VBUS voltage (5.0 V typical) is applied at the **VUSB_DET** input of the module since the switch-on of the module, and then held during normal operations. In this case, the UART will not be available.

²⁴ Not supported by SARA-R422-00B modules

-  AT commands and data communication are not supported via USB interface on SARA-R422-00B, SARA-R422S-00B or SARA-R422M8S-00B product versions: the USB interface is available on these product versions only for firmware upgrade by means of the u-blox dedicated tool and for diagnostic purposes.
-  If the USB interface is enabled, the module does not enter the low power deep sleep mode: the external voltage needs to be removed from the **VUSB_DET / USB_5V0** and **USB_3V3** input pins of the module to let it enter the Power Saving Mode defined in 3GPP Rel.13.
-  It is highly recommended to provide access to the **V_INT, PWR_ON / PWR_CTRL, VUSB_DET / USB_5V0, USB_3V3, USB_D+, USB_D-, RSVD #33** pins for FW update and for diagnostic purpose, by means of test points directly connected to the pins, or by dedicated connector / circuit.

SARA-R410M and SARA-R412M modules provide two USB functions:

- AT commands and data communication
- Diagnostic log

SARA-R422, SARA-R422S and SARA-R422M8S modules provide the following USB function:

- Diagnostic log

For more details regarding USB interface, see the SARA-R4 series system integration manual [2].

2.5.3 SPI interface

-  The SPI interface is not supported by current product versions.

SARA-R410M and SARA-R412M modules include a serial peripheral interface (SPI) over the **I2S_WA / SPI_MOSI, I2S_RXD / SPI_MISO, I2S_CLK / SPI_CLK, I2S_TXD / SPI_CS** pins, for communications with a compatible external device.

2.5.4 SDIO interface

-  The SDIO interface is not supported by current product versions.

SARA-R410M and SARA-R412M modules include a 4-bit secure digital input output (SDIO) interface (**SDIO_D0, SDIO_D1, SDIO_D2, SDIO_D3, SDIO_CLK, and SDIO_CMD**) designed to communicate with external compatible SDIO devices.

2.5.5 DDC (I2C) interface

-  The DDC (I2C) interface is not supported by SARA-R410M-01B product versions.

SARA-R4 series modules include an I2C-bus compatible DDC interface (**SDA, SCL**) available to communicate with an external u-blox GNSS receiver²⁵ and with external I2C devices as for example an audio codec: the SARA-R4 series module acts as an I2C host that can communicate with I2C local devices in accordance with the I2C-bus specifications [15].

The **SDA** and **SCL** pins have internal pull-up to **V_INT**, so there is no need of additional pull-up resistors on the external application board.

²⁵ Dedicated AT commands for the integration with external u-blox GNSS receiver are not supported by SARA-R410M-01B, SARA-R422, or SARA-R422M8S product versions

2.6 Audio

 Audio is not supported by current product versions.

An I2S digital audio interface is included to transfer audio data to/from an external audio device, with the aim of providing Voice over LTE Cat M1 radio bearer (VoLTE) services and CSFB over 2G RAT.

The digital audio interface is available on the SARA-R410M and the SARA-R412M modules over the **I2S_WA / SPI_MOSI, I2S_RXD / SPI_MISO, I2S_CLK / SPI_CLK, I2S_TXD / SPI_CS** pins.

The digital audio interface is available on SARA-R422, SARA-R422S, and SARA-R422M8S modules over the dedicated I2S digital audio interface pins (**I2S_WA, I2S_RXD, I2S_CLK, I2S_TXD**).

2.7 GPIO

SARA-R4 series modules include pins that can be configured as general purpose input/output or to provide custom functions, as summarized in [Table 4](#) (for further details, see the SARA-R4 series system integration manual [\[2\]](#) and the SARA-R4 series AT commands manual [\[1\]](#)).

Function	Description	Default GPIO	Configurable GPIOs
Network status indication	Network status: registered / data transmission, no service	--	GPIO1
External GNSS supply enable ²⁶	Enable/disable the supply of a u-blox GNSS receiver connected to the cellular module by I2C interface	--	GPIO2
External GNSS data ready ²⁶	Sense when a u-blox GNSS receiver connected to the module is ready for sending data by I2C interface	--	GPIO3
SIM card detection	SIM card physical presence detection	--	GPIO5
Ring indicator ²⁷	Events indicator	--	RI
Module status indication	Module switched off or in PSM low power deep sleep mode, versus active or connected mode	--	GPIO1, GPIO2, GPIO3, GPIO4, GPIO5, GPIO6
Last gasp ²⁸	Input to trigger last gasp notification	--	GPIO3, GPIO4, GPIO6 ²⁹
Faster and safe power-off ³⁰	Input to trigger emergency fast and safe shutdown of the module (as triggered by AT+CFUN=10 command)	--	GPIO3, GPIO4
LwM2M pulse ³¹	Output to notify a settable LwM2M event with a configurable pulse	--	GPIO1, GPIO2, GPIO3, GPIO4, GPIO5, GPIO6
General purpose input	Input to sense high or low digital level	--	GPIO1, GPIO2, GPIO3, GPIO4, GPIO5, GPIO6
General purpose output	Output to set the high or the low digital level	--	GPIO1, GPIO2, GPIO3, GPIO4, GPIO6
Pin disabled	Tri-state with an internal active pull-down enabled	GPIO1, GPIO2, GPIO3, GPIO4, GPIO5, GPIO6, RI	GPIO1, GPIO2, GPIO3, GPIO4, GPIO5, GPIO6, RI

Table 4: GPIO custom functions configuration

²⁶ Not supported by SARA-R410M-01B, SARA-R422, or SARA-R422M8S product versions

²⁷ Not supported by SARA-R410M-01B, or SARA-R410M-02B-00 product versions

²⁸ Not supported by SARA-R410M-01B, SARA-R410M-02B-00, or SARA-R422 product versions

²⁹ Not supported by SARA-R422S, or SARA-R422M8S product versions

³⁰ Not supported by SARA-R410M, or SARA-R412M product versions

³¹ Not supported by SARA-R410M-01B, SARA-R410M-02B-00, SARA-R410M-02B-01, SARA-R410M-02B-02, SARA-R410M-52B, SARA-R412M-02B-00, SARA-R412M-02B-01, SARA-R412M-02B-02 product versions

2.8 GNSS peripheral input output

 The GNSS peripheral input output pins are not supported by the SARA-R410M, SARA-R412M, SARA-R422 or SARA-R422S modules.

SARA-R422M8S modules provide the following 1.8 V peripheral input output pins directly connected to the internal u-blox M8 GNSS chipset, as illustrated in [Figure 3](#):

- The **TXD_GNSS** pin provides the UART data output of the internal u-blox M8 GNSS chipset.
- The **EXTINT** external interrupt pin that can be used for control of the GNSS receiver or for aiding.
- The **TIMEPULSE** output pin that can generate pulse trains synchronized with GPS or UTC time grid with intervals configurable over a wide frequency range. Thus it may be used as a low frequency time synchronization pulse or as a high frequency reference signal.
- The **ANT_ON** output pin that can provide optional control for switching off power to an external active GNSS antenna or an external separate LNA. This facility is provided to help minimize power consumption in power save mode operation.

3 Pin definition

3.1 Pin assignment

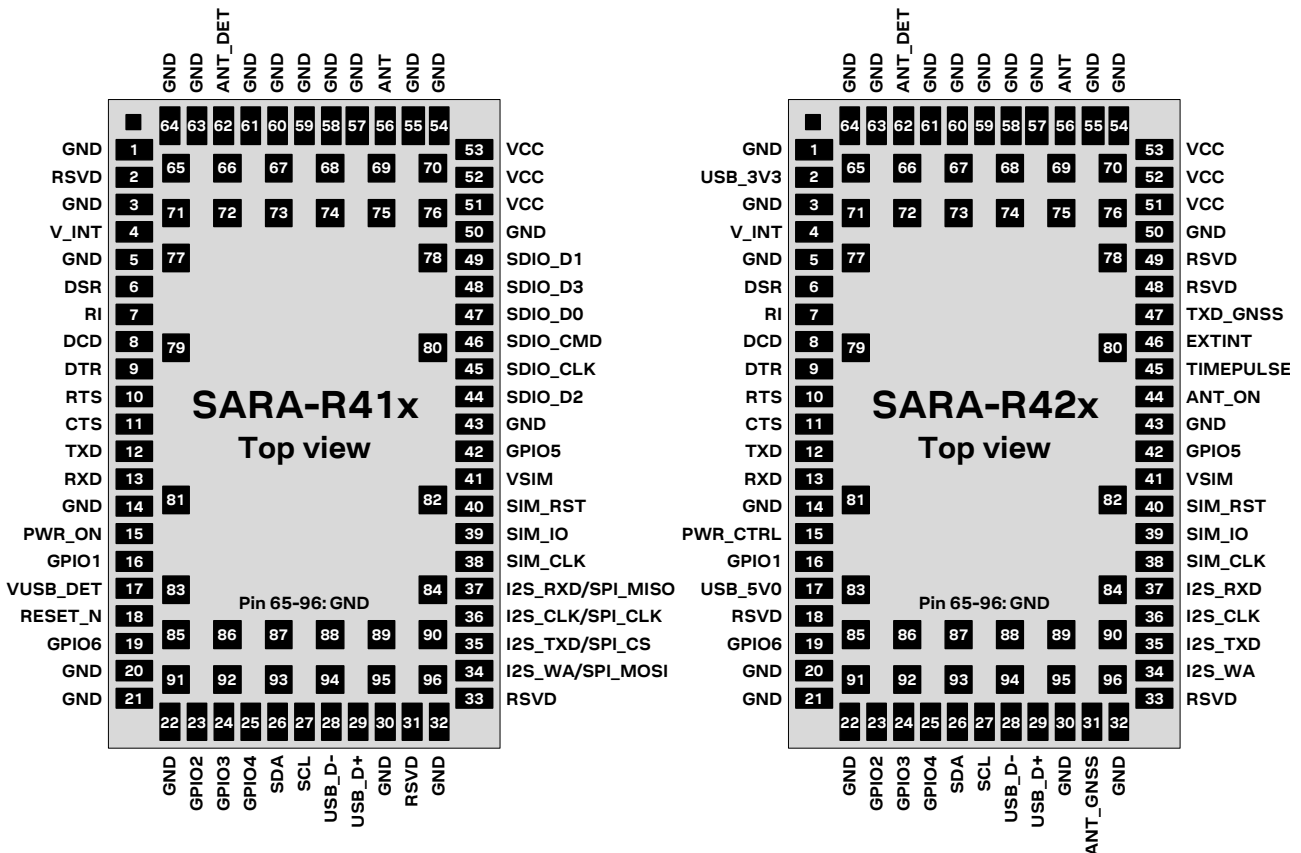

Figure 4: SARA-R4 series pin assignment (top view)

No	Name	Power domain	I/O	Description	Remarks
1	GND	-	N/A	Ground	All the GND pins must be connected to ground
2	RSVD ³²	-	N/A	RESERVED pin	Internally not connected.
	USB_3V3 ³³	USB	I	USB 3V3 supply input	Supply input (3.3 V typical) for internal USB circuits. See section 4.2.13 for detailed electrical specs. Provide test point for diagnostic / FW update purposes.
3	GND	-	N/A	Ground	All the GND pins must be connected to ground
4	V_INT	-	O	Generic Digital Interfaces supply output	V_INT = 1.8 V (typical) generated by the module when is switched on, outside low power PSM deep sleep mode. See section 4.2.3 for detailed electrical specs. Provide test point for diagnostic / FW update purposes.
5	GND	-	N/A	Ground	All the GND pins must be connected to ground
6	DSR	GDI	O/ I	UART data set ready / AUX UART request to send ³³	Circuit 107 (DSR) in ITU-T V.24, alternatively configurable as second auxiliary UART RTS. See section 4.2.15 for detailed electrical specs.
7	RI	GDI	O/ O	UART ring indicator / AUX UART clear to send ³³	Circuit 125 (RI) in ITU-T V.24, alternatively configurable as second auxiliary UART CTS. See section 4.2.15 for detailed electrical specs.

³² SARA-R410M, SARA-R412M modules only

³³ SARA-R422, SARA-R422S, SARA-R422M8S modules only

No	Name	Power domain	I/O	Description	Remarks
8	DCD	GDI	O/ O	UART data carrier detect / AUX UART data output ³⁵	Circuit 109 (DCD) in ITU-T V.24, alternatively configurable as second auxiliary UART data output. See section 4.2.15 for detailed electrical specs.
9	DTR	GDI	I/ I	UART data terminal ready / AUX UART data input ³⁵	Circuit 108/2 (DTR) in ITU-T V.24 with internal active pull-up to V_INT, alternatively configurable as second auxiliary UART data input. See section 4.2.15 for detailed electrical specs.
10	RTS	GDI	I	UART ready to send	Circuit 105 (RTS) in ITU-T V.24. Internal active pull-up to V_INT. Flow control is not supported by SARA-R410M-01B or SARA-R410M-02B-00 product versions. See section 4.2.15 for detailed electrical specs.
11	CTS	GDI	O	UART clear to send	Circuit 106 (CTS) in ITU-T V.24. Flow control is not supported by SARA-R410M-01B, SARA-R410M-02B-00 product versions. See section 4.2.15 for detailed electrical specs.
12	TXD	GDI	I	UART data input	Circuit 103 (TxD) in ITU-T V.24. Internal pull-down to GND on SARA-R410M-02B versions. Internal pull-up to V_INT on other product versions. See section 4.2.15 for detailed electrical specs.
13	RXD	GDI	O	UART data output	Circuit 104 (RxD) in ITU-T V.24. See section 4.2.15 for detailed electrical specs.
14	GND	-	N/A	Ground	All the GND pins must be connected to ground
15	PWR_ON ³⁴	POS	I	Power-on / Power-off input	Internal 200 kΩ pull-up resistor. See section 4.2.9 for detailed electrical specs. Provide test point for diagnostic / FW update purposes.
	PWR_CTRL ³⁵	POS	I	Power-on / Power-off / Reset input	Internal pull-up resistor. See section 4.2.10 for detailed electrical specs. Provide test point for diagnostic / FW update purposes.
16	GPIO1	GDI	I/O	GPIO	Configurable GPIO (see section 2.7). See section 4.2.15 for detailed electrical specs.
17	VUSB_DET ³⁴	USB	I	USB VBUS detect input	Input for USB VBUS (5 V typical) voltage sense. See section 4.2.13 for detailed electrical specs. Provide test point for diagnostic / FW update purposes.
	USB_5V0 ³⁵	USB	I	USB VBUS detect input	Input for USB VBUS (5 V typical) voltage sense. See section 4.2.13 for detailed electrical specs. Provide test point for diagnostic / FW update purposes.
18	RESET_N ³⁴	ERS	I	External reset input	Internal 37 kΩ pull-up resistor to V_INT. See section 4.2.11 for detailed electrical specs. Provide test point for diagnostic purposes.
	RSVD ³⁵	-	N/A	RESERVED pin	Internally not connected.
19	GPIO6	GDI	I/O	GPIO	Configurable GPIO (see section 2.7). See section 4.2.15 for detailed electrical specs.
20	GND	-	N/A	Ground	All the GND pins must be connected to ground
21	GND	-	N/A	Ground	All the GND pins must be connected to ground
22	GND	-	N/A	Ground	All the GND pins must be connected to ground
23	GPIO2	GDI	I/O	GPIO	Configurable GPIO (see section 2.7). See section 4.2.15 for detailed electrical specs.

³⁴ SARA-R410M, SARA-R412M modules only

³⁵ SARA-R422, SARA-R422S, SARA-R422M8S modules only

No	Name	Power domain	I/O	Description	Remarks
24	GPIO3	GDI	I/O	GPIO	Configurable GPIO (see section 2.7). See section 4.2.15 for detailed electrical specs.
25	GPIO4	GDI	I/O	GPIO	Configurable GPIO (see section 2.7). See section 4.2.15 for detailed electrical specs.
26	SDA	DDC	I/O	I2C bus data line	Fixed open drain. Internal 2.2 kΩ pull-up to V_INT. Not supported by SARA-R410M-01B See section 4.2.14 for detailed electrical specs.
27	SCL	DDC	O	I2C bus clock line	Fixed open drain. Internal 2.2 kΩ pull-up to V_INT. Not supported by SARA-R410M-01B See section 4.2.14 for detailed electrical specs.
28	USB_D-	USB	I/O	USB Data Line D-	90 Ω nominal differential impedance. Pull-up, pull-down and series resistors, as required by the USB 2.0 specifications [14], are part of the USB pin driver and shall not be provided externally. See section 4.2.13 for detailed electrical specs. Provide test point for diagnostic / FW update purposes.
29	USB_D+	USB	I/O	USB Data Line D+	90 Ω nominal differential impedance. Pull-up, pull-down and series resistors, as required by USB 2.0 specifications [14], are part of the USB pin driver and shall not be provided externally. See section 4.2.13 for detailed electrical specs. Provide test point for diagnostic / FW update purposes.
30	GND	-	N/A	Ground	All the GND pins must be connected to ground
31	RSVD ³⁶	-	N/A	RESERVED pin	Internally not connected.
	ANT_GNSS ³⁷	-	I	GNSS antenna	RF input for GNSS Rx antenna. 50 Ω nominal impedance. See section 2.2.2 and Table 2 for functional description.
32	GND	-	N/A	Ground	All the GND pins must be connected to ground
33	RSVD	-	N/A	RESERVED pin	This pin can be connected to GND by 0 Ω series jumper. Provide test point for diagnostic purposes.
34	I2S_WA / SPI_MOSI ³⁸	GDI	O / O	I2S word alignment / SPI data output	I2S word alignment / SPI data output Not supported by current product versions See section 4.2.15 for detailed electrical specs.
	I2S_WA ³⁹	GDI	O	I2S word alignment	I2S word alignment Not supported by current product versions See section 4.2.15 for detailed electrical specs.
35	I2S_TXD / SPI_CS ³⁸	GDI	O / O	I2S transmit data / SPI Chip Select	I2S transmit data out / SPI Chip Select Not supported by current product versions See section 4.2.15 for detailed electrical specs.
	I2S_TXD ³⁹	GDI	O	I2S transmit data	I2S transmit data out Not supported by current product versions See section 4.2.15 for detailed electrical specs.
36	I2S_CLK / SPI_CLK ³⁸	GDI	O / O	I2S clock / SPI clock	I2S clock / SPI clock Not supported by current product versions See section 4.2.15 for detailed electrical specs.
	I2S_CLK ³⁹	GDI	O	I2S clock	I2S clock Not supported by current product versions See section 4.2.15 for detailed electrical specs.

³⁶ SARA-R410M, SARA-R412M, SARA-R422, SARA-R422S modules only

³⁷ SARA-R422M8S modules only

³⁸ SARA-R410M, SARA-R412M modules only

³⁹ SARA-R422, SARA-R422S, SARA-R422M8S modules only

No	Name	Power domain	I/O	Description	Remarks
37	I2S_RXD / SPI_MISO ⁴⁰	GDI	I / I	I2S receive data / SPI data input	I2S receive data input / SPI data input Not supported by current product versions See section 4.2.15 for detailed electrical specs.
	I2S_RXD ⁴¹	GDI	I	I2S receive data	I2S receive data input Not supported by current product versions See section 4.2.15 for detailed electrical specs.
38	SIM_CLK	SIM	O	SIM clock	See section 4.2.12 for detailed electrical specs.
39	SIM_IO	SIM	I/O	SIM data	Internal 4.7 kΩ pull-up resistor to VSIM. See section 4.2.12 for detailed electrical specs.
40	SIM_RST	SIM	O	SIM reset	See section 4.2.12 for detailed electrical specs.
41	VSIM	-	O	SIM supply output	VSIM = 1.80 V typical or 2.95 V typical generated by the module according to the external SIM card type. See section 4.2.3 for detailed electrical specs.
42	GPIO5	GDI	I	SIM detection	SIM card presence detection input, alternatively configurable as GPIO (see section 2.7). See section 4.2.15 for detailed electrical specs.
43	GND	-	N/A	Ground	All the GND pins must be connected to ground
44	SDIO_D2 ⁴⁰	GDI	I/O	SDIO serial data [2]	Not supported by current product versions See section 4.2.15 for detailed electrical specs.
	ANT_ON ⁴²	GNSS	O	Antenna / LNA enable	External GNSS active antenna and/or LNA on/off signal driven by u-blox M8 chipset, connected to internal LNA. See section 4.2.16 for detailed electrical specs.
	RSVD ⁴³	-	N/A	RESERVED pin	Internally not connected.
45	SDIO_CLK ⁴⁰	GDI	O	SDIO serial clock	Not supported by current product versions See section 4.2.15 for detailed electrical specs.
	TIMEPULSE ⁴²	GNSS	O	Time Pulse	GNSS time pulse output driven by u-blox M8 chipset. See section 4.2.16 for detailed electrical specs.
	RSVD ⁴³	-	N/A	RESERVED pin	Internally not connected.
46	SDIO_CMD ⁴⁰	GDI	I/O	SDIO command	Not supported by current product versions See section 4.2.15 for detailed electrical specs.
	EXTINT ⁴²	GNSS	I	GNSS external interrupt	GNSS external interrupt connected to u-blox M8 chipset. See section 4.2.16 for detailed electrical specs.
	RSVD ⁴³	-	N/A	RESERVED pin	Internally not connected.
47	SDIO_D0 ⁴⁰	GDI	I/O	SDIO serial data [0]	Not supported by current product versions See section 4.2.15 for detailed electrical specs.
	TXD_GNSS ⁴²	GNSS	O	GNSS data output	GNSS UART data output from internal u-blox M8 chipset. See section 4.2.16 for detailed electrical specs.
	RSVD ⁴³	-	N/A	RESERVED pin	Internally not connected.
48	SDIO_D3 ⁴⁰	GDI	I/O	SDIO serial data [3]	Not supported by current product versions See section 4.2.15 for detailed electrical specs.
	RSVD ⁴¹	-	N/A	RESERVED pin	Internally not connected.
49	SDIO_D1 ⁴⁰	GDI	I/O	SDIO serial data [1]	Not supported by current product versions See section 4.2.15 for detailed electrical specs.
	RSVD ⁴¹	-	N/A	RESERVED pin	Internally not connected.
50	GND	-	N/A	Ground	All the GND pins must be connected to ground

⁴⁰ SARA-R410M, SARA-R412M modules only

⁴¹ SARA-R422, SARA-R422S, SARA-R422M8S modules only

⁴² SARA-R422M8S modules only

⁴³ SARA-R422, SARA-R422S modules only





No	Name	Power domain	I/O	Description	Remarks
51	VCC	-	I	Module supply input	All VCC pins must be connected to external supply. SARA-R410M: supply input for all internal parts. SARA-R412M /-R422 /-R422S /-R422M8S: supply input for internal BB PMU. See section 4.2.3 and 4.2.4 for detailed specs.
52	VCC	-	I	Module supply input	All VCC pins must be connected to external supply. SARA-R410M: supply input for all internal parts. SARA-R412M /-R422 /-R422S /-R422M8S: supply input for internal RF PA. See section 4.2.3 and 4.2.4 for detailed specs.
53	VCC	-	I	Module supply input	All VCC pins must be connected to external supply. SARA-R410M: supply input for all internal parts. SARA-R412M /-R422 /-R422S /-R422M8S: supply input for internal RF PA. See section 4.2.3 and 4.2.4 for detailed specs.
54	GND	-	N/A	Ground	All the GND pins must be connected to ground
55	GND	-	N/A	Ground	All the GND pins must be connected to ground
56	ANT	-	I/O	Cellular antenna	RF input/output for Cellular Rx/Tx antenna. 50 Ω nominal impedance. See section 4.2.6 for detailed electrical specs.
57	GND	-	N/A	Ground	All the GND pins must be connected to ground
58	GND	-	N/A	Ground	All the GND pins must be connected to ground
59	GND	-	N/A	Ground	All the GND pins must be connected to ground
60	GND	-	N/A	Ground	All the GND pins must be connected to ground
61	GND	-	N/A	Ground	All the GND pins must be connected to ground
62	ANT_DET	ADC	I	Antenna detection	Antenna presence detection function. See section 4.2.8 for detailed electrical specs.
63	GND	-	N/A	Ground	All the GND pins must be connected to ground
64	GND	-	N/A	Ground	All the GND pins must be connected to ground
65-96	GND	-	N/A	Ground	All the GND pins must be connected to ground

Table 5: SARA-R4 series pin-out

 For more information about the pin-out, see the u-blox SARA-R4 series system integration manual [2].

 See appendix A for an explanation of the abbreviations and terms used.

4 Electrical specifications

-  Stressing the device above one or more of the ratings listed in the Absolute Maximum Rating section may cause permanent damage. These are stress ratings only. Operating the module at these or at any conditions other than those specified in the Operating Conditions sections (section 4.2) of the specification should be avoided. Exposure to Absolute Maximum Rating conditions for extended periods may affect device reliability.
-  Operating condition ranges define those limits within which the functionality of the device is guaranteed.
-  Electrical characteristics are defined according to the verification on a representative number of samples or according to the simulation.
-  Where application information is given, it is advisory only and does not form part of the specification.

4.1 Absolute maximum rating

-  Limiting values given below are in accordance with Absolute Maximum Rating System (IEC 134).

Symbol	Description	Condition	Min.	Max.	Unit
VCC	Module supply voltage	Input DC voltage at VCC pins (SARA-R422, SARA-R422S, SARA-R422M8S)	-0.5	6.0	V
		Input DC voltage at VCC pins (SARA-R410M, SARA-R412M)	-0.5	5.2	V
VUSB_DET	USB detection pin	Input DC voltage at VUSB_DET pin	-0.5	5.5	V
USB	USB D+/D- pins	Input DC voltage at USB interface pins	-0.3	3.6	V
GDI	Generic digital interfaces	Input DC voltage at Generic digital interfaces pins	-0.3	2.3	V
GNSS	GNSS digital interfaces	Input DC voltage at GNSS digital interfaces pins	-0.3	2.3	V
DDC	DDC (I2C) interface	Input DC voltage at DDC (I2C) interface pins	-0.3	2.3	V
SIM	SIM interface	Input DC voltage at SIM interface pins	-0.3	3.5	V
ERS	External reset input	Input DC voltage at RESET_N pin	-0.5	2.1	V
POS	Power-on input	Input DC voltage at PWR_ON pin	-0.5	2.1	V
ADC	Antenna detection input	Input DC voltage at ANT_DET pin	-0.5	4.3	V
ANT	Cellular RF input/output	Input RF power at ANT pin		3	dBm
ANT_GNSS	GNSS RF input	Input RF power at ANT_GNSS pin, in-band		0	dBm
Rho_ANT	Antenna ruggedness	Output RF load mismatch ruggedness at ANT pin		10:1	VSWR
Tstg	Storage temperature		-40	+85	°C

Table 6: Absolute maximum ratings

-  The product is not protected against overvoltage or reversed voltages. If necessary, voltage spikes exceeding the voltage specifications given in the table above, must be limited to values within the specified boundaries by using appropriate protection devices.

4.1.1 Maximum ESD

Parameter	Min	Typical	Max	Unit	Remarks
ESD sensitivity for all pins			1'000	V	Human Body Model according to JESD22-A114

Table 7: Maximum ESD ratings

-  u-blox cellular modules are Electrostatic Sensitive Devices and require special precautions when handling. See section 7.4 for ESD handling instructions.

4.2 Operating conditions

Unless otherwise indicated, all operating condition specifications are at an ambient temperature of +25 °C.

Operation beyond the operating conditions is not recommended and extended exposure beyond them may affect device reliability.

4.2.1 Operating temperature range

Parameter	Min.	Typ.	Max.	Unit	Remarks
Normal operating temperature	-20	+25	+65	°C	Normal operating temperature range (fully functional and meet 3GPP / ETSI specifications)
Extended operating temperature	-40		+85	°C	Extended operating temperature range (RF performance may be affected outside normal operating range, though module is fully functional)

Table 8: Environmental conditions

4.2.2 Thermal parameters

Symbol	Parameter	Min.	Typ.	Max.	Unit	Remarks
Ψ_{M-A}	Module-to-Ambient thermal parameter		10		°C/W	Thermal characterization parameter $\Psi_{M-A} = (T_M - T_A) / P_H$ proportional to the difference between internal temperature (T_M) and the ambient temperature (T_A), produced by heat power dissipation (P_H), with the module mounted on a 79 x 62 x 1.41 mm 4-Layer PCB with a high coverage of copper, in still air conditions
Ψ_{M-C}	Module-to-Case thermal parameter		2		°C/W	Thermal characterization parameter $\Psi_{M-C} = (T_M - T_C) / P_H$ proportional to the difference between internal temperature (T_M) and the ambient temperature (T_C), produced by heat power dissipation (P_H), with the module mounted on a 79 x 62 x 1.41 mm 4-Layer PCB with a high coverage of copper, robust aluminum heat-sink and forced air ventilation, reducing to ~0 °C/W the thermal resistance from the case of the module to the ambient

Table 9: Thermal characterization parameters of the module

4.2.3 Supply/power pins

Symbol	Parameter	Modules	Min.	Typical	Max.	Unit
VCC	Module supply normal operating input voltage ⁴⁴	SARA-R410M	3.2	3.8	4.2	V
		SARA-R412M and SARA-R42 series	3.2	3.8	4.5	V
	Module supply extended operating input voltage ⁴⁵	SARA-R410M	3.0	3.8	4.3	V
		SARA-R412M and SARA-R42 series	3.0	3.8	4.5	V

Table 10: Input characteristics of the Supply/Power pins

Symbol	Parameter	Modules	Min.	Typical	Max.	Unit
VSIM	SIM supply output voltage with 1.8 V external SIM	All		1.80		V
	SIM supply output voltage with 3.0 V external SIM	All		2.95		V
V_INT	Generic Digital Interfaces supply output voltage	All		1.80		V
	Generic Digital Interfaces supply output current capability	All			70	mA

Table 11: Output characteristics of the Supply/Power pins

⁴⁴ Input voltage at VCC must be above the normal operating range minimum limit to switch on the module. RF performance may be affected when the input voltage at VCC drops below the herein stated normal operating range minimum limit, though the module is still fully functional.

⁴⁵ Ensure that input voltage at VCC never drops below the extended operating range minimum limit during module operation: the cellular module may switch off when the VCC voltage value drops below the herein stated extended operating range minimum limit.⁴⁶ All values with VCC = 3.8 V, with UART connected, with USB disconnected.

4.2.4 Current consumption

Mode	Condition	Tx power	Modules	Min	Typ	Max	Unit
Power Off Mode (module switched off)	Averaged current value	--	R410M, R412M		6		μA
			R422, R422S, R422M8S		3		μA
PSM Deep Sleep Mode (RTC on)	Averaged current value	--	R410M, R412M		8		μA
			R422, R422S, R422M8S		3		μA
Low Power Mode (+UPSV: 4)	Averaged current value (rock bottom, without deep sleep in between eDRX)	--	R410M, R412M		0.6		mA
			R422, R422S, R422M8S		0.4		mA
	Averaged current value (rock bottom, with deep sleep in between eDRX)	--	R422, R422S, R422M8S		3		μA
	Averaged current value (no deep sleep in between eDRX cycle of 20.48 s)	--	R410M, R412M		0.9		mA
			R422, R422S, R422M8S		0.6		mA
Averaged current value (no deep sleep in between eDRX cycle of 655.36 s)	--	R410M, R412M		0.7		mA	
		R422, R422S, R422M8S		0.5		mA	
Averaged current value (deep sleep in between eDRX cycle of 655.36 s)	--	R422, R422S, R422M8S		0.1		mA	
Active Mode (Power Saving / Low Power Mode disabled, registered with network)	Averaged current value	--	All		9		mA
LTE NB-IoT Connected Mode (Data Tx / Rx)	Averaged current value	Minimum	R410M, R412M		60		mA
			R422, R422S, R422M8S		65		mA
	Peak current value during Tx	Maximum	R410M		140		mA
			R412M		240		mA
			R422, R422S, R422M8S		230		mA
Peak current value during Tx	Maximum	R410M			0.5	A	
		R412M			0.9	A	
		R422, R422S, R422M8S			0.8	A	
LTE Cat M1 Connected Mode (Data Tx / Rx)	Averaged current value	Minimum	R410M, R412M		100		mA
			R422, R422S, R422M8S		105		mA
	Peak current value during Tx	Maximum	R410M		190		mA
			R412M		360		mA
			R422, R422S, R422M8S		350		mA
Peak current value during Tx	Maximum	R410M			0.5	A	
		R412M			0.9	A	
		R422, R422S, R422M8S			0.8	A	
2G Connected Mode (Data Tx / Rx)	Averaged current value during GMSK 1-Tx/1-Rx call 850/900 MHz bands	Maximum	R412M		200		mA
			R422, R422S, R422M8S		250		mA
	Peak current value during GMSK 1-slot Tx, 850/900 MHz bands	Maximum	R412M		1.5	1.9	A
			R422, R422S, R422M8S		1.9	2.5	A

Table 12: Module VCC current consumption, with GNSS off ⁴⁶

⁴⁶ All values with VCC = 3.8 V, with UART connected, with USB disconnected.

Mode / Condition	Min	Typ	Max	Unit
Average current value with power saving enabled (+UPSV=4), Cellular modem in PSM, UBX-M8 in cyclic tracking mode with 1 s update period (GPS)		6		mA
Average current value with power saving enabled (+UPSV=4), Cellular modem in PSM, UBX-M8 in cyclic tracking mode with 1 s update period (GPS & GLONASS)		7		mA
Average current value with power saving enabled (+UPSV=4), Cellular modem in PSM, UBX-M8 in continuous tracking mode (GPS & GLONASS)		20		mA
Average current value with power saving enabled (+UPSV=4), Cellular modem in DRX = 1.28 s, UBX-M8 in cyclic tracking mode with 1 s update period (GPS)		7		mA
Average current value with power saving enabled (+UPSV=4), Cellular modem in DRX = 1.28 s, UBX-M8 in cyclic tracking with 1 s update period (GPS & GLONASS)		8		mA
Average current value with power saving enabled (+UPSV=4), Cellular modem in DRX = 1.28 s, UBX-M8 in continuous tracking mode (GPS & GLONASS)		21		mA
Average current value with power saving disabled (+UPSV=0), Cellular modem in DRX = 1.28 s, UBX-M8 in continuous tracking mode (GPS & GLONASS)		32		mA
Average current value with power saving disabled (+UPSV=0), Cellular modem in DRX = 1.28 s, UBX-M8 in acquisition mode (GPS & GLONASS)		38		mA
Peak current value with power saving disabled (+UPSV=0), Cellular modem in DRX = 1.28 s, UBX-M8 in acquisition mode (GPS & GLONASS)			75	mA

Table 13: Indicative VCC current consumption of the SARA-R422M8S module, with GNSS on

4.2.5 GNSS characteristics

Parameter	Condition	Value				
Receiver type		72-channel u-blox M8 engine GPS L1C/A, SBAS L1C/A, QZSS L1C/A, QZSS L1-SAIF, GLONASS L1OF, BeiDou B1I, Galileo E1B/C				
Operational limits ⁴⁷	Dynamics	≤ 4 g				
	Altitude	50'000 m				
	Velocity	500 m/s				
Velocity accuracy ⁴⁸		0.05 m/s				
Heading accuracy ⁴⁸		0.3 degrees				
GNSS		GPS & GLONASS	GPS	GLONASS	BeiDou	Galileo
Horizontal position accuracy ⁴⁹		2.5 m	2.5 m	4 m	3 m	3 m
Max navigation update rate		10 Hz	18 Hz	18 Hz	18 Hz	18 Hz
Time-To-First-Fix ⁵⁰	Cold start	26 s	29 s	30 s	34 s	45 s
	Aided starts ⁵¹	2 s	2 s	2 s	3 s	7 s
Sensitivity	Tracking & Navigation	-167 dBm	-166 dBm	-166 dBm	-160 dBm	-159 dBm
	Reacquisition	-160 dBm	-160 dBm	-156 dBm	-157 dBm	-153 dBm
	Cold start	-148 dBm	-148 dBm	-145 dBm	-143 dBm	-138 dBm

Table 14: GNSS characteristics and performance of the SARA-R422M8S module
⁴⁷ Assuming Airborne < 4 g platform

⁴⁸ 50% @ 30 m/s

⁴⁹ CEP, 50%, 24 hours static, -130 dBm, > 6 SVs

⁵⁰ All satellites at -130 dBm, except Galileo at -127 dBm

⁵¹ Dependent on aiding data connection speed and latency

⁵² LTE Cat M1 only

4.2.6 LTE RF characteristics

The LTE bands supported by SARA-R4 series modules are defined in the [Table 2](#), while the following [Table 15](#) describes the Transmitting and Receiving frequencies according to 3GPP TS 36.521-1 [11].

Parameter		Min.	Max.	Unit	Remarks
Frequency range FDD band 85 (700 MHz)	Uplink	698	716	MHz	Module transmits
	Downlink	728	746	MHz	Module receives
Frequency range FDD band 12 (700 MHz)	Uplink	699	716	MHz	Module transmits
	Downlink	729	746	MHz	Module receives
Frequency range FDD band 28 (700 MHz)	Uplink	703	748	MHz	Module transmits
	Downlink	758	803	MHz	Module receives
Frequency range FDD band 13 (700 MHz)	Uplink	777	787	MHz	Module transmits
	Downlink	746	756	MHz	Module receives
Frequency range FDD band 20 (800 MHz)	Uplink	832	862	MHz	Module transmits
	Downlink	791	821	MHz	Module receives
Frequency range FDD band 26 (850 MHz)	Uplink	814	849	MHz	Module transmits
	Downlink	859	894	MHz	Module receives
Frequency range FDD band 18 (850 MHz)	Uplink	815	830	MHz	Module transmits
	Downlink	860	875	MHz	Module receives
Frequency range FDD band 19 (850 MHz)	Uplink	830	845	MHz	Module transmits
	Downlink	875	890	MHz	Module receives
Frequency range FDD band 5 (850 MHz)	Uplink	824	849	MHz	Module transmits
	Downlink	869	894	MHz	Module receives
Frequency range FDD band 8 (900 MHz)	Uplink	880	915	MHz	Module transmits
	Downlink	925	960	MHz	Module receives
Frequency range FDD band 4 (1700 MHz)	Uplink	1710	1755	MHz	Module transmits
	Downlink	2110	2155	MHz	Module receives
Frequency range FDD band 66 (1700 MHz)	Uplink	1710	1780	MHz	Module transmits
	Downlink	2110	2200	MHz	Module receives
Frequency range FDD band 3 (1800 MHz)	Uplink	1710	1785	MHz	Module transmits
	Downlink	1805	1880	MHz	Module receives
Frequency range FDD band 2 (1900 MHz)	Uplink	1850	1910	MHz	Module transmits
	Downlink	1930	1990	MHz	Module receives
Frequency range FDD band 25 (1900 MHz)	Uplink	1850	1915	MHz	Module transmits
	Downlink	1930	1995	MHz	Module receives
Frequency range FDD band 1 (2100 MHz)	Uplink	1920	1980	MHz	Module transmits
	Downlink	2110	2170	MHz	Module receives

Table 15: LTE operating RF frequency bands

The SARA-R4 series modules include a UE Power Class 3 LTE Cat M1 / NB1 / NB2 transmitter (see [Table 2](#)), with output power and characteristics according to 3GPP TS 36.521-1 [11].

SARA-R4 series modules LTE receiver characteristics are compliant to 3GPP TS 36.521-1 [11], with LTE conducted receiver sensitivity performance described in [Table 16](#) and [Table 17](#).

Parameter	Min.	Typical	Max.	Unit	Remarks
Receiver input sensitivity band 12 / 85		-108.5		dBm	Without repetitions
Receiver input sensitivity band 13		-108.5		dBm	Without repetitions
Receiver input sensitivity band 28		-108.5		dBm	Without repetitions
Receiver input sensitivity band 20		-108.0		dBm	Without repetitions
Receiver input sensitivity band 5 / 18 / 19 / 26		-108.0		dBm	Without repetitions
Receiver input sensitivity band 8		-107.5		dBm	Without repetitions
Receiver input sensitivity band 3		-108.0		dBm	Without repetitions
Receiver input sensitivity band 2 / 25		-108.5		dBm	Without repetitions
Receiver input sensitivity band 1 / 4 / 66		-108.5		dBm	Without repetitions

Condition: 50 Ω source, throughput > 95%, QPSK modulation, other settings as per clause 7.3EA of 3GPP TS 36.521-1 [11]

Table 16: LTE Cat M1 receiver sensitivity performance

Parameter	Min.	Typical	Max.	Unit	Remarks
Receiver input sensitivity band 12 / 85		-116.5		dBm	Without repetitions
Receiver input sensitivity band 13		-116.5		dBm	Without repetitions
Receiver input sensitivity band 28		-116.5		dBm	Without repetitions
Receiver input sensitivity band 20		-116.0		dBm	Without repetitions
Receiver input sensitivity band 5 / 18 / 19 / 26		-116.0		dBm	Without repetitions
Receiver input sensitivity band 8		-116.0		dBm	Without repetitions
Receiver input sensitivity band 3		-116.0		dBm	Without repetitions
Receiver input sensitivity band 2 / 25		-116.5		dBm	Without repetitions
Receiver input sensitivity band 1 / 4 / 66		-116.5		dBm	Without repetitions

Condition: 50 Ω source, throughput > 95%, other settings as per clause 7.3F.1 of 3GPP TS 36.521-1 [11]

Table 17: LTE Cat NB1 receiver sensitivity performance

4.2.7 2G RF characteristics

The 2G bands supported by SARA-R4 series modules are defined in the [Table 2](#), while the following [Table 18](#) describes the Transmitting and Receiving frequencies according to 3GPP TS 51.010-1 [12].

Parameter		Min	Max	Unit	Remarks
Frequency range GSM 850	Uplink	824	849	MHz	Module transmits
	Downlink	869	894	MHz	Module receives
Frequency range E-GSM 900	Uplink	880	915	MHz	Module transmits
	Downlink	925	960	MHz	Module receives
Frequency range DCS 1800	Uplink	1710	1785	MHz	Module transmits
	Downlink	1805	1880	MHz	Module receives
Frequency range PCS 1900	Uplink	1850	1910	MHz	Module transmits
	Downlink	1930	1990	MHz	Module receives

Table 18: 2G operating RF frequency bands

The SARA-R412M, SARA-R422, SARA-R422S, and SARA-R422M8S modules include a GMSK Power Class 4 transmitter for the GSM 850 and E-GSM 900 bands, a GMSK Power Class 1 transmitter for the DCS 1800 and PCS 1900 bands, a 8-PSK Power Class E2 transmitter for all the 2G bands (see [Table 2](#)), with output power and characteristics according to 3GPP TS 51.010-1 [12].

SARA-R4 series modules 2G receiver characteristics are compliant to 3GPP TS 51.010-1 [12], with conducted receiver sensitivity performance described in [Table 19](#).

Parameter	Min	Typical	Max	Unit	Remarks
GSM 850 receiver input sensitivity		-109		dBm	Downlink RF level @ BER Class II < 2.4 %
E-GSM 900 receiver input sensitivity		-109		dBm	Downlink RF level @ BER Class II < 2.4 %
DCS 1800 receiver input sensitivity		-109		dBm	Downlink RF level @ BER Class II < 2.4 %
PCS 1900 receiver input sensitivity		-109		dBm	Downlink RF level @ BER Class II < 2.4 %

Condition: 50 Ω source

Table 19: 2G receiver sensitivity performance

4.2.8 ANT_DET pin

Pin Name	Parameter	Min.	Typ.	Max.	Unit	Remarks
ANT_DET	Output DC current pulse value		35		μA	
	Output DC current pulse time length		1160		μs	

Table 20: ANT_DET pin characteristics

4.2.9 PWR_ON pin

Parameter	Min.	Typical	Max.	Unit	Remarks
Internal supply for PWR_ON Input Signal		1.8		V	The PWR_ON input is pulled up to an internal voltage rail minus a diode drop: the voltage value present at PWR_ON input pin is normally 0.8 V typical.
Low-level input	-0.30		0.35	V	
Pull-up resistance	150	200	250	kΩ	Internal active pull-up
Input leakage current	-0.20		0.20	μA	
PWR_ON low time	0.15		3.20	s	Low time to trigger module switch on from power off mode
	0.15		3.20	s	Low time to trigger module wake-up from PSM deep sleep
	1.50			s	Low time to trigger module graceful switch off

Table 21: PWR_ON pin characteristics

4.2.10 PWR_CTRL pin

Parameter	Min.	Typical	Max.	Unit	Remarks
Internal supply for PWR_CTRL Input Signal		1.5		V	The PWR_ON input is pulled up to an internal voltage rail.
Low-level input	-0.30		0.35	V	
PWR_CTRL low time	0.01		12.0	s	Low time to trigger module switch on from power off mode
	0.01		12.0	s	Low time to trigger module wake-up from PSM deep sleep
	1.10		14.0	s	Low time to trigger module graceful switch off
	16.0			s	Low time to trigger module abrupt emergency reset (reboot)

Table 22: PWR_CTRL pin characteristics

4.2.11 RESET_N pin

Parameter	Min.	Typical	Max.	Unit	Remarks
Internal supply for RESET_N Input Signal		1.8		V	
Low-level input	-0.30		0.63	V	
Pull-up resistance		37		kΩ	Internal active pull-up
Input leakage current	-0.20		0.20	μA	
RESET_N low time	10			s	Low time to trigger module abrupt emergency switch off

Table 23: RESET_N pin characteristics

4.2.12 SIM pins

The SIM pins are a dedicated interface to the external SIM card/chip. The electrical characteristics fulfill the regulatory specification requirements. The values in [Table 24](#) are for information only.

Parameter	Min.	Typ.	Max.	Unit	Remarks
Low-level input	-0.30		0.2*VSIM	V	
High-level input		0.7*VSIM	VSIM+0.3	V	
Low-level output		0	0.4	V	Max value at IOL = +2.0 mA
High-level output		0.8*VSIM	VSIM	V	Max value at IOL = +2.0 mA
Internal pull-up resistor on SIM_IO		4.7		kΩ	Internal pull-up to VSIM supply
Input leakage current	-2		2	μA	VIN =0 V or VIN =VSIM
Clock frequency on SIM_CLK		4.8		MHz	

Table 24: SIM pins characteristics

4.2.13 USB pins

USB data lines (**USB_D+**/ **USB_D-**) are compliant to the USB 2.0 high-speed specification. See the Universal Serial Bus revision 2.0 specification [\[14\]](#) for detailed electrical characteristics.

Parameter	Min.	Typical	Max.	Unit	Remarks
Input voltage on pin VUSB_DET / USB_5V0	4.40	5.00	5.25	V	Sense input to enable the USB interface
Input voltage on pin USB_3V3		3.30		V	Supply input for the USB interface
High-speed squelch detection threshold (input differential signal amplitude)	100		150	mV	
High speed disconnect detection threshold (input differential signal amplitude)	525		625	mV	

Parameter	Min.	Typical	Max.	Unit	Remarks
High-speed data signaling input common mode voltage range	-50		500	mV	
High-speed idle output level	-10		10	mV	
High-speed data signaling output high level	360		440	mV	
High-speed data signaling output low level	-10		10	mV	
Chirp J level (output differential voltage)	700		1100	mV	
Chirp K level (output differential voltage)	-900		-500	mV	

Table 25: USB pins characteristics

4.2.14 DDC (I2C) pins

DDC (I2C) lines (**SCL** and **SDA**) are compliant to the I2C-bus standard mode specification. See the I2C-bus specification [15] for detailed electrical characteristics.

Parameter	Min	Typical	Max	Unit	Remarks
Internal supply for GDI domain		1.80		V	Digital I/O Interfaces supply (V_INT)
Low-level input	-0.30	0.00	0.63	V	
High-level input	1.17	1.80	2.10	V	
Low-level output		0.00	0.45	V	Max value at I _{OL} = +2.0 mA
Internal pull-up resistance		2.2		kΩ	
Input/output leakage current	-1		1	μA	V _{IN} = 0 V or V _{IN} = 1.8V
Clock frequency on SCL		100		kHz	

Table 26: DDC (I2C) pins characteristics

4.2.15 Generic digital interfaces pins

Parameter	Min	Typical	Max	Unit	Remarks
Internal supply for GDI domain		1.80		V	Digital I/O Interfaces supply (V_INT)
Low-level input	-0.30	0.00	0.63	V	
High-level input	1.17	1.80	2.10	V	
Low-level output		0.00	0.45	V	Max value at IOL = +2.0 mA
High-level output	1.35	1.80		V	Min value at IOH = -2.0 mA
Input leakage current	-1		1	μA	V _{IN} = 0 V or V _{IN} = 1.8V
Internal pull-up / pull-down resistance	55		390	kΩ	

Table 27: GDI pins characteristics

4.2.16 GNSS digital interfaces pins

Parameter	Min	Typical	Max	Unit	Remarks
Internal supply for GNSS domain		1.80		V	
Low-level input	0.00		0.36	V	
High-level input	1.26		1.80	V	
Low-level output		0.00	0.40	V	Max value at IOL = +4.0 mA
High-level output	1.40	1.80		V	Min value at IOH = -4.0 mA

Table 28: GNSS pins characteristics

4.3 Parameters for ATEX applications

This section provides useful parameters and information to integrate SARA-R4 series modules in applications intended for use in areas with potentially explosive atmospheres (ATEX), describing:

- Total internal capacitance and inductance of the modules (see [Table 29](#))
- Maximum RF output power at the antenna (**ANT**) pin of the modules (see [Table 30](#))

Any specific applicable requirement for the implementation of the apparatus integrating the SARA-R4 series modules, intended for use in potentially explosive atmospheres, must be fulfilled according to the exact applicable standards: check the detailed requisites on the pertinent normative for the application, as for example the IEC 60079-0 [\[16\]](#), IEC 60079-11 [\[17\]](#), and IEC 60079-26 [\[18\]](#) standards.

The certification of the application device that integrates a SARA-R4 series module and the compliance of the application device with all the applicable certification schemes, directives and standards required for use in potentially explosive atmospheres are the sole responsibility of the application device manufacturer.

[Table 29](#) describes the maximum total internal capacitance and the maximum total internal inductance, considering internal parts tolerance, of the SARA-R4 series modules.

Module	Parameter	Description	Value	Unit
SARA-R410M	Ci	Maximum total internal capacitance	504	μF
	Li	Maximum total internal inductance	9.3	μH
SARA-R412M	Ci	Maximum total internal capacitance	507	μF
	Li	Maximum total internal inductance	9.4	μH
SARA-R422, SARA-R422S	Ci	Maximum total internal capacitance	264	μF
	Li	Maximum total internal inductance	2.0	μH
SARA-R422M8S	Ci	Maximum total internal capacitance	280	μF
	Li	Maximum total internal inductance	2.0	μH

Table 29: SARA-R4 series maximum total internal capacitance and maximum total internal inductance

[Table 30](#) describes the maximum RF output power transmitted by SARA-R4 series modules from the antenna (**ANT**) pin as Power Class 3 User Equipment for the LTE bands and/or as Power Class 4 Mobile Stations for GSM 850 / E-GSM 900 bands.

Module	Parameter	Description	Value	Unit
SARA-R410M	ANT Pout	Maximum RF output power from ANT pin	25.00	dBm
SARA-R412M, SARA-R422, SARA-R422S, SARA-R422M8S	ANT Pout	Maximum RF output power from ANT pin	33.00	dBm

Table 30: SARA-R4 series maximum RF output power

SARA-R4 series modules do not contain internal blocks that increase the input voltage (such as step-up, duplicators, or boosters) except for the antenna (**ANT**) pin, for which the maximum RF output power shown in [Table 30](#).

5 Mechanical specifications

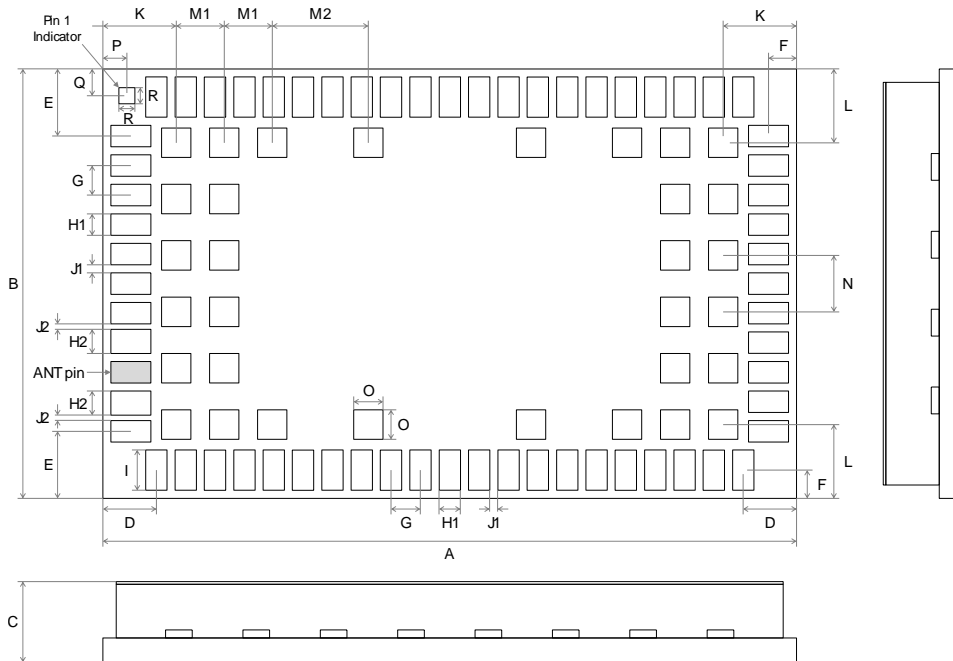

Figure 5: SARA-R4 series dimensions (bottom and side views)

Parameter	Description	Typical	Tolerance
A	Module height [mm]	26.0 (1023.6 mil)	+0.20/-0.20 (+7.9/-7.9 mil)
B	Module width [mm]	16.0 (629.9 mil)	+0.20/-0.20 (+7.9/-7.9 mil)
C	Module thickness [mm] (SARA-R41x series)	2.53 (99.5 mil)	+0.25/-0.15 (+9.8/-5.9 mil)
	Module thickness [mm] (SARA-R42x series)	2.12 (83.5 mil)	+0.25/-0.15 (+9.8/-5.9 mil)
D	Horizontal edge to lateral pin pitch [mm]	2.0 (78.7 mil)	+0.20/-0.20 (+7.9/-7.9 mil)
E	Vertical edge to lateral pin pitch [mm]	2.5 (98.4 mil)	+0.20/-0.20 (+7.9/-7.9 mil)
F	Edge to lateral pin pitch [mm]	1.05 (41.3 mil)	+0.20/-0.20 (+7.9/-7.9 mil)
G	Lateral pin to pin pitch [mm]	1.1 (43.3 mil)	+0.05/-0.05 (+2.0/-2.0 mil)
H1	Lateral pin height [mm]	0.8 (31.5 mil)	+0.05/-0.05 (+2.0/-2.0 mil)
H2	Lateral pin close to ANT height [mm]	0.9 (35.4 mil)	+0.05/-0.05 (+2.0/-2.0 mil)
I	Lateral pin width [mm]	1.5 (59.1 mil)	+0.05/-0.05 (+2.0/-2.0 mil)
J1	Lateral pin to pin distance [mm]	0.3 (11.8 mil)	+0.05/-0.05 (+2.0/-2.0 mil)
J2	Lateral pin to pin close to ANT distance [mm]	0.2 (7.9 mil)	+0.05/-0.05 (+2.0/-2.0 mil)
K	Horizontal edge to central pin pitch [mm]	2.75 (108.3 mil)	+0.20/-0.20 (+7.9/-7.9 mil)
L	Vertical edge to central pin pitch [mm]	2.75 (108.3 mil)	+0.20/-0.20 (+7.9/-7.9 mil)
M1	Central pin to pin horizontal pitch [mm]	1.8 (70.9 mil)	+0.05/-0.05 (+2.0/-2.0 mil)
M2	Central pin to pin horizontal pitch [mm]	3.6 (141.7 mil)	+0.05/-0.05 (+2.0/-2.0 mil)
N	Central pin to pin vertical pitch [mm]	2.1 (82.7 mil)	+0.05/-0.05 (+2.0/-2.0 mil)
O	Central pin height and width [mm]	1.1 (43.3 mil)	+0.05/-0.05 (+2.0/-2.0 mil)
P	Horizontal edge to pin 1 indicator pitch [mm]	0.9 (35.4 mil)	+0.20/-0.20 (+7.9/-7.9 mil)
Q	Vertical edge to pin 1 indicator pitch [mm]	1.0 (39.4 mil)	+0.20/-0.20 (+7.9/-7.9 mil)
R	Pin 1 indicator height and width [mm]	0.6 (23.6 mil)	+0.05/-0.05 (+2.0/-2.0 mil)
Weight	Module weight [g]	< 3	

Table 31: SARA-R4 series dimensions

- Module height tolerance ± 0.20 mm may be exceeded close to the corners of the PCB due to the cutting process: in the worst cases, the height could be $+0.40$ mm longer than the typical value.
- For information regarding footprint and paste mask recommended for the application board integrating the cellular module, see the SARA-R4 series system integration manual [2].

6 Qualification and approvals

6.1 Approvals

SARA-R4 series modules comply with the Directive 2011/65/EU of the European Parliament and the Council on the Restriction of Use of certain Hazardous Substances in Electrical and Electronic Equipment (EU RoHS 2) and its amendment Directive (EU) 2015/863 (EU RoHS 3).

SARA-R4 series modules are RoHS 3 compliant.

No natural rubbers, hygroscopic materials, or materials containing asbestos are employed.

[Table 32](#) summarizes the main approvals for SARA-R410M and SARA-R412M modules.

Certification	SARA-R410M-01B	SARA-R410M-02B	SARA-R410M-52B	SARA-R410M-63B	SARA-R410M-73B	SARA-R410M-83B	SARA-R412M-02B
PTCRB	LTE Cat M1 band 2,4,5,12	LTE Cat M1, NB1 band 2,3,4,5,8,12,13,20,28	LTE Cat M1 band 2,4,5,12,13				LTE Cat M1, NB1 band 2,4,5,12
GCF			LTE Cat M1 band 2,4,5,12,13				
CE Europe		LTE Cat M1, NB1 band 3,8,20				LTE Cat M1, NB1 band 3,8,20	LTE Cat M1, NB1 band 3,8,20 2G band 900,1800
FCC US	LTE Cat M1 band 2,4,5,12	LTE Cat M1, NB1 band 2,4,5,12,13,25 ⁵²	LTE Cat M1 band 2,4,5,12,13				LTE Cat M1, NB1 band 2,4,5,12,13 2G band 850,1900
FCC ID	XPY2AGQN4NNN	XPY2AGQN4NNN	XPY2AGQN4NNN				XPYUBX18ZO01
ISED Canada	LTE Cat M1 band 2,4,5,12	LTE Cat M1, NB1 band 2,4,5,12,13	LTE Cat M1 band 2,4,5,12,13				LTE Cat M1, NB1 band 2,4,5,12,13 2G band 850,1900
ISED ID	8595A-2AGQN4NNN	8595A-2AGQN4NNN	8595A-2AGQN4NNN				8595A-UBX18ZO01
ACMA Australia		LTE Cat M1 band 3,5,8,28				LTE Cat M1, NB1 band 3,5,8,28	LTE Cat M1, NB1 band 3,5,8,28
NCC Taiwan		LTE Cat M1, NB1 band 3,8,28				LTE Cat M1, NB1 band 3,8,28	
GITEKI Japan		LTE Cat M1, NB1 band 1,8,18,19,26		LTE Cat M1, NB1 band 1,8,18,19,26			
KC Korea						LTE Cat M1 band 3,5,26	

⁵² LTE Cat M1 only

Certification	SARA-R410M-01B	SARA-R410M-02B	SARA-R410M-52B	SARA-R410M-63B	SARA-R410M-73B	SARA-R410M-83B	SARA-R412M-02B
ANATEL Brazil		LTE Cat M1, NB1 band 3,5,28					LTE Cat M1, NB1 band 3,5,28 2G band 850,900,1800,1900
Verizon		LTE Cat M1 band 4,13	LTE Cat M1 band 4,13				
AT&T	LTE Cat M1 band 2,4,5,12	LTE Cat M1 band 2,4,5,12	LTE Cat M1 band 2,4,5,12				LTE Cat M1 band 2,4,5,12
Sprint		LTE Cat M1 band 25					
Bell	LTE Cat M1 band 2,4,5,12						
Telus	LTE Cat M1 band 2,4,5,12	LTE Cat M1 band 2,4,5,12					
Rogers		LTE Cat M1, NB1 band 2,4,5,12					
Telstra		LTE Cat M1 band 3,5,8,28				LTE Cat M1, NB1 band 3,5,8,28	
Softbank				LTE Cat M1 band 1,8			
NTT DOCOMO				LTE Cat M1 band 1,19			
SKT					LTE Cat M1 band 3,5,26		
Deutsche Telekom		LTE Cat M1, NB1 band 3,8,20					LTE Cat M1, NB1 band 3,8,20 2G band 900,1800

Note: Certification of cellular radio modules is no longer mandatory according to current IFT Mexico regulatory rules



Table 32: Summary of main certification approvals for SARA-R410M and SARA-R412M modules, with related RAT and bands

- For guidelines and notices about compliance with certification approvals requirements of end-devices integrating a SARA-R41 series module, see the SARA-R4 series system integration manual [2] and the u-blox SARA-R41 series application development guide application note [6].
- The certification approvals listed in Table 32 above might not be available for all the different product type numbers. Please contact the u-blox office or sales representative nearest you for the full comprehensive list of approvals and for further specific info about all country, conformance, and network operators' certifications available for the selected product ordering number.

Table 33 summarizes the main approvals for SARA-R422, SARA-R422S and SARA-R422M8S modules.

Certification	SARA-R422 / SARA-R422S / SARA-R422M8S
PTCRB	LTE-M bands 1, 2, 3, 4, 5, 8, 12, 13, 20, 25, 26, 28, 66; NB-IoT bands 1, 2, 3, 4, 5, 8, 12, 13, 20, 28, 66, 85; 2G bands 850, 900, 1800, 1900
GCF	LTE-M bands 1, 2, 3, 4, 5, 8, 12, 13, 20, 25, 26, 28, 66; NB-IoT bands 1, 2, 3, 4, 5, 8, 12, 13, 20, 28, 66, 85; 2G bands 850, 900, 1800, 1900
CE Europe	LTE-M bands 1, 3, 8, 20, 28; NB-IoT bands 1, 3, 8, 20, 28; 2G bands 900, 1800
FCC US FCC ID	LTE-M bands 2, 4, 5, 8, 12, 13, 25, 26, 66; NB-IoT bands 2, 4, 5, 8, 12, 13, 66, 85; 2G bands 850, 1900 XPYUBX20VA01
ISED Canada ISED ID	LTE-M bands 2, 4, 5, 12, 13, 25, 26, 66; NB-IoT bands 2, 4, 5, 12, 13, 66, 85; 2G bands 850, 1900 8595A-UBX20VA01
ACMA Australia	LTE-M bands 3, 5, 8, 28; NB-IoT bands 3, 5, 8, 28
NCC Taiwan	LTE-M bands 3, 8, 28; NB-IoT bands 3, 8, 28
ANATEL Brazil	LTE-M bands 1, 2, 3, 5, 8, 28; NB-IoT bands 1, 2, 3, 5, 8, 28; 2G bands 850, 900, 1800, 1900
GITEKI Japan ⁵³	LTE-M bands 1, 3, 8, 18, 19, 26, 28; NB-IoT bands 1, 3, 8, 18, 19, 26, 28
KC Korea ⁵³	LTE-M bands 3, 5, 26; NB-IoT bands 3, 5
Verizon ⁵³	LTE-M bands 4, 13; NB-IoT bands 4, 13
AT&T ⁵³	LTE-M bands 2, 4, 12; NB-IoT bands 2, 4, 12
T-Mobile ⁵³	LTE-M bands 2, 4, 5, 12, 66; NB-IoT bands 2, 4, 5, 12, 66, 85; 2G bands 850, 1900
Vodafone	NB-IoT bands 3, 8, 20; 2G bands 900, 1800
Deutsche Telekom	LTE-M bands 3, 8, 20; NB-IoT bands 3, 8, 20; 2G bands 900, 1800
Note:	Certification of cellular radio modules is no longer mandatory according to current IFT Mexico regulatory rules

Table 33: Summary of main certification approvals for SARA-R422, SARA-R422S and SARA-R422M8S modules, with related RAT and bands

-  For guidelines and notices about compliance with certification approvals requirements of end-devices integrating a SARA-R42 series module, see the SARA-R4 series system integration manual [2] and the u-blox SARA-R42 series application development guide application note [7].
-  The certification approvals listed in Table 33 above might not be available for all the different product type numbers. Please contact the u-blox office or sales representative nearest you for the full comprehensive list of approvals and for further specific info about all country, conformance and network operators' certifications available for the selected product ordering number.

⁵³ Planned for future product version

Table 34 summarizes how some of the SARA-R4 series modules are identified by various bodies.

Body	Description	SARA-R410M-01B	SARA-R410M-02B	SARA-R410M-52B	SARA-R412M-02B
PTCRB	Model Name	SARA-R410M	SARA-R410M-02B	SARA-R410M-52B	SARA-R412M
GCF	Model Name	--	--	SARA-R410M-52B	--
	Marketing Name	--	--	SARA-R410M-52B	--
GSMA	Model Name	SARA-R410M	SARA-R410M	SARA-R410M-52B	SARA-R412M
	Marketing Name	SARA-R410M	SARA-R410M-02B	SARA-R410M-52B	SARA-R412M
FCC US	ID	XPY2AGQN4NNN	XPY2AGQN4NNN	XPY2AGQN4NNN	XPYUBX18ZO01
	Product Name	SARA-R410M	SARA-R410M-02B	SARA-R410M-02B	SARA-R412M
ISED Canada	ID	8595A-2AGQN4NNN	8595A-2AGQN4NNN	8595A-2AGQN4NNN	8595A-UBX18ZO01
	HVIN	SARA-R410M	SARA-R410M	SARA-R410M	SARA-R412M
	PMN	SARA-R410M	SARA-R410M	SARA-R410M	SARA-R412M
RED Europe	Model Name	--	SARA-R410M-02B	--	SARA-R412M
ACMA Australia	Model Number	--	SARA-R410M-02B	--	SARA-R412M-02B
AT&T	Model Name	SARA-R410M	SARA-R410M-02B	SARA-R410M-52B	SARA-R412M
Verizon	Model Name	--	SARA-R410M-02B	SARA-R410M-52B	--
Sprint	Model Name	--	SARA-R410M	--	--
Deutsche Telekom	Model Name	--	SARA-R410M-02B	--	SARA-R412M-02B
Telstra	Model Name	--	SARA-R410M-02B	--	--

Table 34: Summary of some SARA-R4 series modules' identification by various bodies

6.2 Reliability tests

Tests for product family qualifications according to ISO 16750 “Road vehicles – Environmental conditions and testing for electrical and electronic equipment”, and appropriate standards.

7 Product handling & soldering

7.1 Packaging

SARA-R4 series modules are delivered as hermetically sealed, reeled tapes to enable efficient production, production lot set-up and tear-down. For more information about packaging, see the u-blox package information user guide [3].

7.1.1 Reels

SARA-R4 series modules are deliverable in quantities of 250 pieces on a reel. The modules are delivered using reel type B2 described in Figure 6 and in the u-blox package information user guide [3].

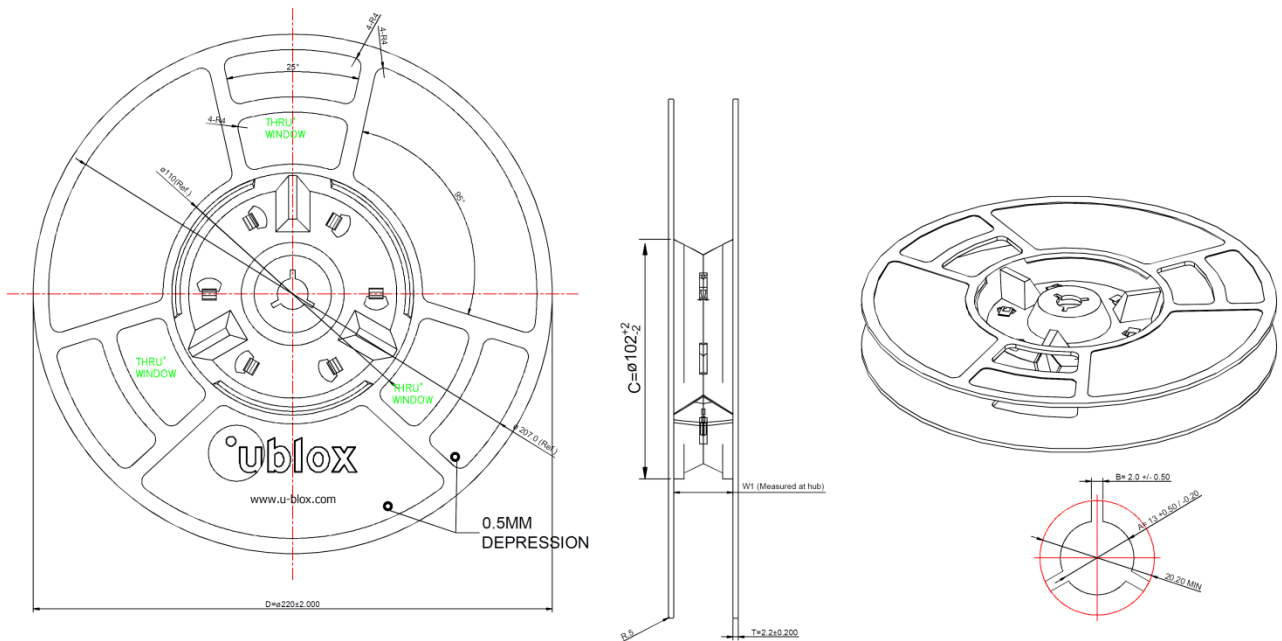

NOTE: ALL DIMENSIONS IN MILLIMETERS

Figure 6: SARA-R4 series modules reel

Parameter	Specification
Reel type	B2
Delivery quantity	250

Table 35: Reel information for SARA-R4 series modules

Quantities of less than 250 pieces are also available. Contact u-blox for more information.

7.1.2 Tapes

Figure 7 shows the position and the orientation of SARA-R4 series modules as they are delivered on the tape, while Figure 8 and Table 36 specify the dimensions of the tape.

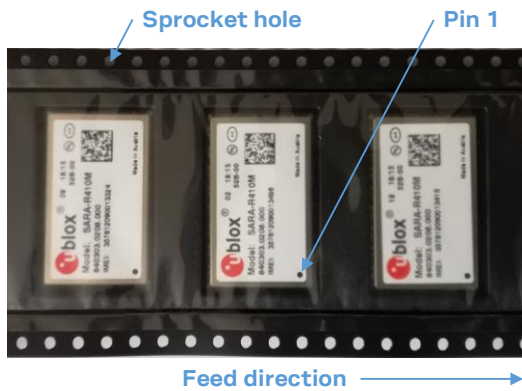

Figure 7: Orientation of SARA-R4 series modules on tape

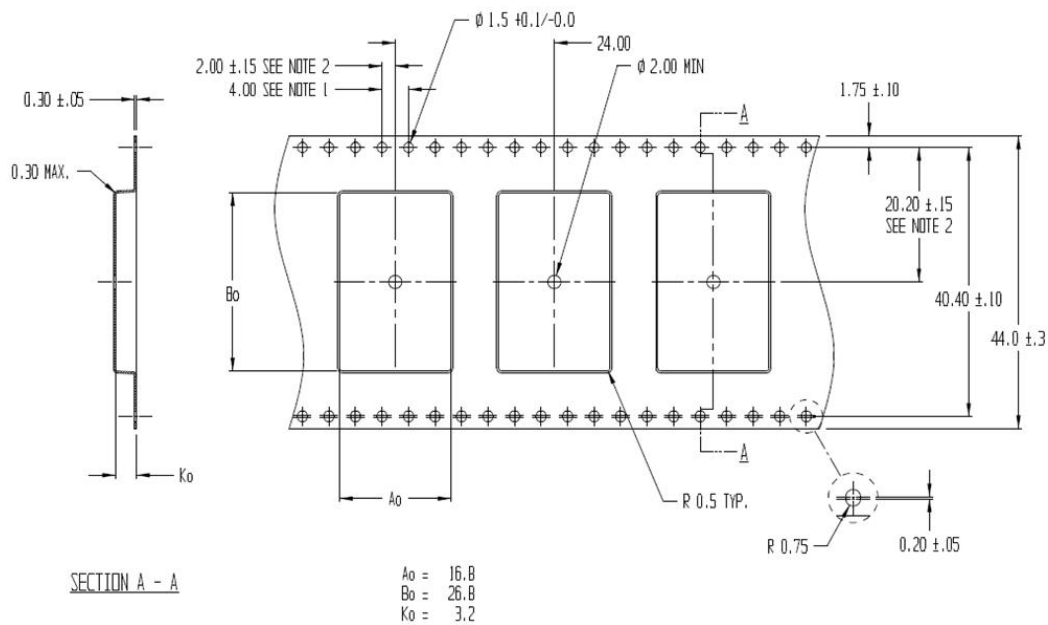



Figure 8: SARA-R4 series modules tape

Parameter	Typical value	Tolerance	Unit
A_0	16.8	0.2	mm
B_0	26.8	0.2	mm
K_0	3.2	0.2	mm

Table 36: SARA-R4 series tape dimensions (mm)

- 10 sprocket hole pitch cumulative tolerance ± 0.2 mm.
- Pocket position relative to sprocket hole is measured as true position of pocket, not pocket hole.
- A_0 and B_0 are calculated on a plane at a distance “R” above the bottom of the pocket.

7.2 Moisture Sensitivity Levels

-  SARA-R4 series modules are Moisture Sensitive Devices (MSD) in accordance to the IPC/JEDEC specification.

The Moisture Sensitivity Level (MSL) relates to the packaging and handling precautions required. SARA-R4 series modules are rated at MSL level 4. For more information regarding moisture sensitivity levels, labeling, storage and drying, see the u-blox package information user guide [3].

-  For the MSL standard, see IPC/JEDEC J-STD-020 (can be downloaded from www.jedec.org).

7.3 Reflow soldering

Reflow profiles are to be selected according to u-blox recommendations (see the SARA-R4 series system integration manual [2]).

-  Failure to observe these recommendations can result in severe damage to the device!

7.4 ESD precautions

-  SARA-R4 series modules contain highly sensitive electronic circuitry and are Electrostatic Sensitive Devices (ESD). Handling SARA-R4 series modules without proper ESD protection may destroy or damage them permanently.

SARA-R4 series modules are Electrostatic Sensitive Devices (ESD) and require special ESD precautions typically applied to ESD sensitive components.

[Table 7](#) details the maximum ESD ratings of the SARA-R4 series modules.

Proper ESD handling and packaging procedures must be applied throughout the processing, handling and operation of any application that incorporates the SARA-R4 series module.

ESD precautions should be implemented on the application board where the module is mounted, as described in the SARA-R4 series system integration manual [2].

-  Failure to observe these recommendations can result in severe damage to the device!

8 Labeling and ordering information

8.1 Product labeling

The labels of SARA-R4 series modules include important product information as described in this section. [Figure 9](#) illustrates the label of the SARA-R4 series modules, and includes: u-blox logo, production lot, Pb-free marking, product type number, IMEI number, certification information, and production country.

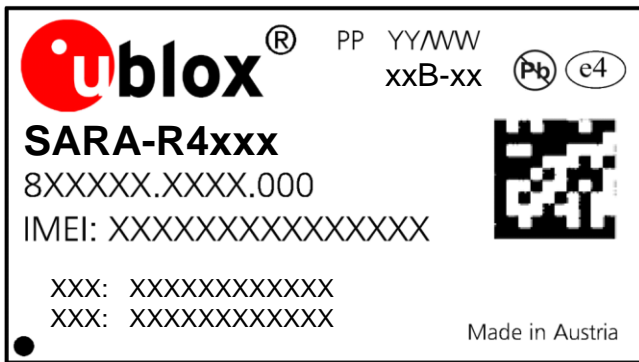

Figure 9: SARA-R4 series module label

8.2 Explanation of codes

Three different product code formats are used. The **Product name** is used in documentation such as this data sheet and identifies all the u-blox products, independent of packaging and quality grade. The **Ordering code** includes options and quality, while the **Type number** includes the hardware and firmware versions. [Table 37](#) details these 3 different formats:

Format	Structure
Product name	PPPP-TGVV(L)(HH)(F)
Ordering code	PPPP-TGVV(L)(HH)(F)-MMQ
Type number	PPPP-TGVV(L)(HH)(F)-MMQ-XX

Table 37: Product code formats

[Table 38](#) explains the parts of the product code.

Code	Meaning	Example
PPPP	Form factor	SARA
TG	Platform (technology and generation) <ul style="list-style-type: none"> Dominant technology: G: GSM; U: HSUPA; C: CDMA 1xRTT; N: NB-IoT (LTE Cat NB1/NB2); R: LTE low data rate (Cat 1 and Cat M1); L: LTE high data rate (Cat 3 and above) Generation: 1...9 	R4
VV	Variant function set based on the same platform: 00...99	04
(L)	LTE category (optionally indicated): 6,4,3,1,M ...	M
(HH)	GNSS generation (indicated if supported): M8 = u-blox M8, M9 = u-blox M9, ...	M8
(F)	Additional features (optionally indicated if supported): S = secure cloud, ...	S
MM	Major product version: 00...99	00
Q	Product grade: B = professional, A = automotive	B
XX	Minor product version: 00...99	00

Table 38: Part identification code

8.3 Ordering information

Ordering No.	Product
SARA-R410M-01B	LTE Cat M1 module Designed for operation in LTE bands 2, 4, 5, 12 deployed by AT&T and other North American MNOs 26.0 x 16.0 mm, 250 pieces/reel
SARA-R410M-02B	LTE Cat M1 / NB1 module Mainly designed for operation in LTE bands 2, 3, 4, 5, 8, 12, 13, 20, 25, 28 deployed in multi-regions 26.0 x 16.0 mm, 250 pieces/reel
SARA-R410M-52B	LTE Cat M1 module Designed for operation in LTE bands 2, 4, 5, 12, 13 deployed by AT&T and Verizon MNOs 26.0 x 16.0 mm, 250 pieces/reel
SARA-R410M-63B	Secure Cloud LTE Cat M1 module Designed for operation in LTE bands 1, 8, 19 deployed by Japanese NTT DOCOMO and SoftBank MNOs 26.0 x 16.0 mm, 250 pieces/reel
SARA-R410M-73B	Secure Cloud LTE Cat M1 module Designed for operation in LTE bands 3, 5, 26 deployed by Korean SKT MNO 26.0 x 16.0 mm, 250 pieces/reel
SARA-R410M-83B	Secure Cloud LTE Cat M1 / NB1 module Designed for operation in LTE bands 3, 5, 8, 20, 28 deployed in APAC and other regions 26.0 x 16.0 mm, 250 pieces/reel
SARA-R412M-02B	LTE Cat M1 / NB1 and 2G module Mainly designed for operation in LTE bands 2, 3, 4, 5, 8, 12, 13, 20, 28 and 2G quad-band in multi-regions 26.0 x 16.0 mm, 250 pieces/reel
SARA-R422-00B	LTE Cat M1 / NB2 and 2G module Designed for operation in LTE bands 1, 2, 3, 4, 5, 8, 12, 13, 20, 25, 26, 28, 66, 85 and 2G quad-band 26.0 x 16.0 mm, 250 pieces/reel
SARA-R422S-00B	Secure Cloud LTE Cat M1 / NB2 and 2G module Designed for operation in LTE bands 1, 2, 3, 4, 5, 8, 12, 13, 20, 25, 26, 28, 66, 85 and 2G quad-band 26.0 x 16.0 mm, 250 pieces/reel
SARA-R422M8S-00B	Secure Cloud LTE Cat M1 / NB2 and 2G module, with integrated u-blox M8 GNSS receiver Designed for operation in LTE bands 1, 2, 3, 4, 5, 8, 12, 13, 20, 25, 26, 28, 66, 85 and 2G quad-band 26.0 x 16.0 mm, 250 pieces/reel

Table 39: Product ordering codes

Appendix

A Glossary

Abbreviation	Definition
3GPP	3 rd Generation Partnership Project
8PSK	8 Phase-Shift Keying modulation
ACMA	Australian Communications and Media Authority
ADC	Analog to Digital Converter
ANATEL	Agência Nacional de Telecomunicações - National Telecommunications Agency (Brazil)
BeiDou	Chinese satellite navigation system
Cat	Category
CSFB	Circuit Switched Fall Back
DDC	Display Data Channel (I2C compatible) Interface
DL	Down-link (Reception)
DRX	Discontinuous Reception
DTLS	Datagram Transport Layer Security
eDRX	Extended Discontinuous Reception
ERS	External Reset Input Signal
ESD	Electrostatic Discharge
FCC	Federal Communication Commission (United States)
FDD	Frequency Division Duplex
FOAT	Firmware update Over AT commands
FOTA	Firmware update Over The Air
FW	Firmware
GCF	Global Certification Forum
GDI	Generic Digital Interfaces (power domain)
GITEKI	Gijutsu kijun tekigō shōmei - technical standard conformity certification (Japan)
GLONASS	Russian satellite navigation system
GMSK	Gaussian Minimum-Shift Keying modulation
GND	Ground
GNSS	Global Navigation Satellite System
GPIO	General Purpose Input Output
GPS	Global Positioning System
GSMA	GSM Association
I	Input (means that this is an input port of the module)
I2C	Inter-Integrated Circuit Interface
I2S	Inter-Integrated circuit Sound Interface
IFT	Instituto Federal de Telecomunicaciones (Mexico)
IMEI	International Mobile Equipment Identity
ISED	Innovation, Science and Economic Development (Canada)
LGA	Land Grid Array
LNA	Low Noise Amplifier
LPWA	Low Power Wide Area
LTE	Long Term Evolution
LTE-M	Long-Term Evolution – enhanced Machine Type Communication (LTE Category M1)

Abbreviation	Definition
LwM2M	Open Mobile Alliance Lightweight Machine-to-Machine protocol
MQTT	Message Queuing Telemetry Transport
N/A	Not Applicable
NB-IoT	Narrowband Internet of Things (LTE Category NB1 / LTE Category NB2)
NCC	National Communications Commission (Taiwan)
O	Output (means that this is an output port of the module)
OD	Open Drain
PA	Power Amplifier
PCN	Product Change Notification / Sample Delivery Note / Information Note
POS	Power-On Input Signal
PPS	Pulse Per Second
PSM	Power Saving Mode
PTCRB	PCS Type Certification Review Board
QZSS	Quasi-Zenith Satellite System
RAT	Radio Access Technology
RCM	Regulatory Compliance Mark (Australia)
RED	Radio Equipment Directive (European Union)
RMC	Reference Measurement Channel
SAW	Surface Acoustic Wave
SBAS	Satellite-Based Augmentation System
SDIO	Secure Digital Input Output
SIM	Subscriber Identity Module
SPI	Serial Peripheral Interface
SSL	Secure Socket Layer
TBD	To Be Defined
TBS	Transport Block Size
TCP	Transmission Control Protocol
TDD	Time Division Duplex
TLS	Transport Layer Security
UART	Universal Asynchronous Receiver-Transmitter serial interface
UDP	User Datagram Protocol
uFOTA	u-blox Firmware update Over-The-Air
UL	Up-link (Transmission)
USB	Universal Serial Bus
VoLTE	Voice over LTE

Table 40: Explanation of the abbreviations and terms used

Related documentation

- [1] u-blox SARA-R4 series AT commands manual, [UBX-17003787](#)
- [2] u-blox SARA-R4 series system integration manual, [UBX-16029218](#)
- [3] u-blox package information user guide, [UBX-14001652](#)
- [4] u-blox SARA-R4 series security suite application note, [UBX-20013561](#)
- [5] u-blox SARA-R4 series backup and restore technical note, [UBX-20053119](#)
- [6] u-blox SARA-R41 series application development guide application note, [UBX-18019856](#)
- [7] u-blox SARA-R42 series application development guide application note, [UBX-20050829](#)
- [8] 3GPP TS 27.007 - AT command set for User Equipment (UE)
- [9] 3GPP TS 27.005 - Use of Data Terminal Equipment - Data Circuit terminating Equipment (DTE - DCE) interface for Short Message Service (SMS) and Cell Broadcast Service (CBS)
- [10] 3GPP TS 27.010 - Terminal Equipment to User Equipment (TE-UE) multiplexer protocol
- [11] 3GPP TS 36.521-1 - Evolved Universal Terrestrial Radio Access; User Equipment conformance specification; Radio transmission and reception; part 1: conformance testing
- [12] 3GPP TS 51.010-1 - Mobile Station conformance specification; part 1: conformance specification
- [13] ITU-T Recommendation V24, 02-2000. List of definitions for interchange circuits between Data Terminal Equipment (DTE) and Data Connection Equipment (DCE)
- [14] Universal Serial Bus revision 2.0 specification, <https://www.usb.org/>
- [15] I2C-bus specification and user manual - UM10204 - NXP semiconductors, <https://www.nxp.com/docs/en/user-guide/UM10204.pdf>
- [16] IEC 60079-0 - Explosive atmospheres, part 0: equipment general requirements
- [17] IEC 60079-11 - Explosive atmospheres, part 11: equipment protection by intrinsic safety 'i'
- [18] IEC 60079-26 - Explosive atmospheres, part 26: equipment with EPL Ga

 For regular updates to u-blox documentation and to receive product change notifications, register on our homepage (www.u-blox.com).

Revision history

Revision	Date	Name	Comments
R01	07-Oct-2016	sfal	Initial release
R02	02-Feb-2017	sfal	Updated supported features and electrical characteristics
R03	05-May-2017	sfal / sses	Updated supported features and electrical characteristics Added the SARA-R410M-01B product version
R04	24-May-2017	sses	Updated supported features and electrical characteristics
R05	19-Jul-2017	sses	Updated supported features and electrical characteristics Extended document applicability to SARA-R410M-02B product version
R06	17-Aug-2017	sses	Updated supported features for "02B" product version
R07	30-Oct-2017	sses	Updated SARA-R410M-01B product status Updated supported features for "02B" product version
R08	04-Jan-2018	sses	Updated SARA-R410M-02B product status Updated USB, GPIO and other features description
R09	26-Feb-2018	sses	Updated SARA-R410M-02B product status Extended document applicability to SARA-R412M-02B product version Added Current consumption, Rx sensitivity and Thermal figures Updated UART MUX and Approvals info
R10	07-Mar-2018	mbab	u-blox rebranding. Updated SARA-R412M-02B modem and app version

Revision	Date	Name	Comments
R11	09-May-2018	sses	Updated SARA-R410M-02B product status. Extended document applicability to SARA-N410-02B product version. Updated UART and Approvals info
R12	10-Aug-2018	sses	Extended document applicability to SARA-R410M-52B product version Updated SARA-N410-02B and SARA-R412M-02B product status Clarified supported bands. Added some current consumption figures
R13	20-Sep-2018	lpah	Extended document applicability to SARA-R404M-00B-01 type number Clarified mode supported in frequency bands
R14	12-Nov-2018	sses	Updated SARA-N410-02B product status. Updated certification info
R15	15-Feb-2019	sses	Updated SARA-R412M-02B product status. Revised supported bands. Updated certification info. Added current consumption figures. Added parameters for ATEX applications. Added orientation of modules on tape
R16	14-Jun-2019	sses	Extended document applicability to the product versions SARA-R410M-02B-01, SARA-R410M-52B-01 and SARA-R412M-02B-01. Revised product description, approvals, and other info according to extension of document applicability.
R17	27-Sep-2019	sses	Extended document applicability to the product versions SARA-R410M-03B, SARA-R410M-63B, SARA-R410M-73B, and SARA-R412M-03B. Updated product status of SARA-R410M-02B, SARA-R410M-52B, and SARA-N410-02B.
R18	20-Dec-2019	sses	Removed the document applicability to the product versions SARA-R410M-03B, SARA-R412M-03B. Updated product status of SARA-R410M-63B. Other minor corrections and clarifications.
R19	11-Jun-2020	sses	Extended document applicability to SARA-R410M-83B product version. Updated product status of SARA-R410M-63B, SARA-R410M-73B. Added approvals info. Other minor corrections and clarifications.
R20	28-Aug-2020	sses	Extended document applicability to the product versions SARA-R410M-02B-02, SARA-R410M-52B-02, and SARA-R412M-02B-02
R21	11-Nov-2020	sses	Extended document applicability to the product versions SARA-R410M-73B-01, SARA-R410M-83B-01
R22	09-Dec-2020	sses	Extended document applicability to the product versions SARA-R410M-63B-01
R23	23-Feb-2021	sses	Extended document applicability to the product versions SARA-R410M-02B-03, SARA-R412M-02B-03. Other minor corrections and clarifications
R24	02-Apr-2021	sses	Extended document applicability to SARA-R422-00B, SARA-R422M8S-00B, SARA-R422S-00B. Other minor corrections and clarifications
R25	02-Jul-2021	sses	Updated product status of SARA-R422-00B, SARA-R422M8S-00B and SARA-R422S-00B Clarified power-off section. Other minor corrections and clarifications

Contact

For complete contact information, visit us at www.u-blox.com.

u-blox Offices

North, Central and South America

u-blox America, Inc.

Phone: +1 703 483 3180
Email: info_us@u-blox.com

Regional Office West Coast:

Phone: +1 408 573 3640
Email: info_us@u-blox.com

Technical Support:

Phone: +1 703 483 3185
Email: support@u-blox.com

Headquarters

Europe, Middle East, Africa

u-blox AG

Phone: +41 44 722 74 44
Email: info@u-blox.com
Support: support@u-blox.com

Asia, Australia, Pacific

u-blox Singapore Pte. Ltd.

Phone: +65 6734 3811
Email: info_ap@u-blox.com
Support: support_ap@u-blox.com

Regional Office Australia:

Phone: +61 3 9566 7255
Email: info_anz@u-blox.com
Support: support_ap@u-blox.com

Regional Office China (Beijing):

Phone: +86 10 68 133 545
Email: info_cn@u-blox.com
Support: support_cn@u-blox.com

Regional Office China (Chongqing):

Phone: +86 23 6815 1588
Email: info_cn@u-blox.com
Support: support_cn@u-blox.com

Regional Office China (Shanghai):

Phone: +86 21 6090 4832
Email: info_cn@u-blox.com
Support: support_cn@u-blox.com

Regional Office China (Shenzhen):

Phone: +86 755 8627 1083
Email: info_cn@u-blox.com
Support: support_cn@u-blox.com

Regional Office India:

Phone: +91 80 405 092 00
Email: info_in@u-blox.com
Support: support_in@u-blox.com

Regional Office Japan (Osaka):

Phone: +81 6 6941 3660
Email: info_jp@u-blox.com
Support: support_jp@u-blox.com

Regional Office Japan (Tokyo):

Phone: +81 3 5775 3850
Email: info_jp@u-blox.com
Support: support_jp@u-blox.com

Regional Office Korea:

Phone: +82 2 542 0861
Email: info_kr@u-blox.com
Support: support_kr@u-blox.com

Regional Office Taiwan:

Phone: +886 2 2657 1090
Email: info_tw@u-blox.com
Support: support_tw@u-blox.com